

E4 wristband

from **empatica** 

user's manual

START TRACKING NOW

empatica.com/get-started-e4

INTRODUCTION

The E4 wristband is a class IIa Medical Device in the EU, according to CE Cert. No. 1876/MDD (93/ 42/EEC Directive)

The Empatica E4 wristband is a wearable wireless device designed for comfortable, continuous, real-time data acquisition in daily life. The E4 contains four sensors:

- Photoplethysmography (PPG) to provide blood volume pulse, from which heart rate, heart rate variability, and other cardiovascular features may be derived.
- Electrodermal activity (EDA), used to measure sympathetic nervous system arousal and to derive features related to stress, engagement, and excitement.
- 3-axis accelerometer, to capture motion-based activity.
- Infrared thermopile, reading skin temperature.

The E4 operates either in streaming mode for real-time data viewing on a mobile device using Bluetooth® low energy or in recording mode using its internal memory.

Empatica provides software tools that enable your E4 data to be transferred securely and easily to other devices:

- Empatica connect is a web application for storing, viewing, and managing E4 data. The application can be accessed from any platform using a contemporary web browser. To get started, set up a free account at: <https://www.empatica.com/connect>

- E4 Realtime is a mobile App that provides wireless streaming and visualization of real-time E4 data on Bluetooth® Smart Ready mobile devices including iPhone, iPod touch, iPad, and many Android phones and tablets. Free from the App store or Google Play.
- E4 Manager is a desktop application for managing the E4. E4 manager runs on macOS & Windows. It transfers data from the E4 and uploads it securely to the E4 Connect. Download for free at: <https://www.empatica.com/product-e4-download>

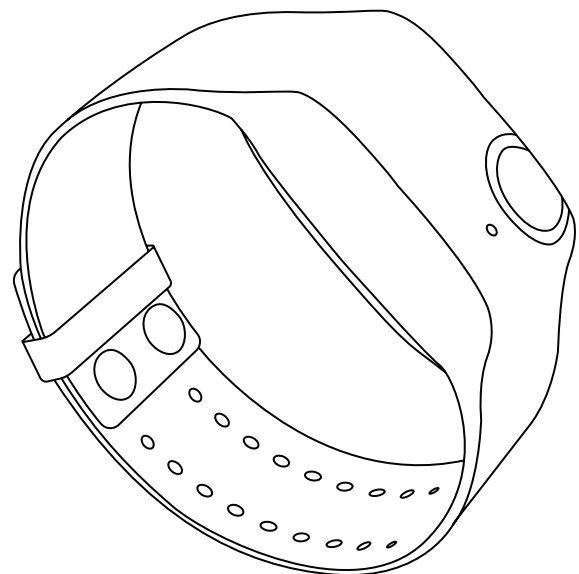

INTENDED USE AND USERS

Indication for use statement

The E4 is intended to be worn on the wrist for continuous collection of physiological data in the home and healthcare setting for use by healthcare professionals. This includes blood volume, heart rate and physical activity. The E4 is also intended for the measurement of electrodermal response and physical activity in patients with neurological disorders such as epilepsy. The E4 is not intended as a primary diagnosis of epilepsy or detection of seizures.

User types

- Patient – uses the device for a prolonged time and is being measured
- Operator - setup the work modality of the device and review the physiological data

User modalities

- Other the counter: The subject uses the E4 as a monitoring tool.
- Prescription: A physician uses the device on a patient for monitoring its physiological data and conducts studies on those data.

A. PRECAUTIONS FOR USE

Synthesis of cautions



The list below represents all aspects that should be considered as cautions resulting from Risk analysis of the E4. The user is required to carefully read this manual before using the device.

Functional hazards – including any error that might result from errant read and /or transfer of data that affects the output of one or more sensor (i.e., Heart rate, EDA, Temperature, Accelerometers).

Very Low risk level - no harm – safe transfer protocols and fault detection algorithms monitor the validity of data. Moreover the E4 is not intended to diagnose a disease; only trained personnel may interpret the data.

Current leakage through the EDA electrodes – The EDA circuit drives a small amount of ionic current through the skin to operate: Max 100 μ A as required by IEC 60601-1:2005

Very Low risk level - no harm – the E4 has been validated to be compliant with ISO 60601-1:2005 after design validation and verification, which means that the amount of current produced is safe for the user.

Eye exposition to LED light - PPG LEDs are extremely bright; typically they are totally obscured by contact with the skin. However the User can remove the E4 from the wrist, exposing the light source.

Very Low risk level - no harm – the quantity of light is comparable with other light sources that Users may be exposed in their daily environment. The User is advised to not look at the PPG LEDs for a prolonged time.

Heat produced by PPG LEDs – PPG LEDs might produce heat

Very Low risk level - no harm – the LEDs are not in direct contact with the skin and the PPG window produces sufficient insulation to protect the skin from the levels of heat that may be produced by the LEDs.

Battery

Very Low risk level - no harm – batteries have a low energy density and an explosion is a rare event. Batteries are qualified before use and are also certified by the Supplier.

Skin inspection and sensor relocation

After a prolonged use above 24h, the user should inspect the skin and determine if a skin irritation was produced by the device. This is probably due to the mechanical interference between the skin and the device (the E4 passed all biological safety tests). Thus in this situation it is suggested to stop the recording or switch the recording location, by placing the E4 in the other wrist.

Water resistance

Very Low risk level – no harm – the device is splash proof and will operate normally after contact with sweat, rain or splashes. The device is not fully waterproof so the user should not submerge it in liquid or wear it in the shower. In the event that there is water ingress into the case the User will not be harmed, but the device may stop working.

Biocompatibility

Very Low risk level – no harm - the E4 is made of a well known biocompatible material and the manufacturer is qualified, ensuring that no contamination occurs during the manufacturing process. Materials are outlined in Technical Specifications section.

Electromagnetic compatibility

Very Low risk level – no harm – design validation and verification has been conducted and has demonstrated that the E4 is safe for use with other electronic devices. It is compliant with the following standards:

- IEC 60601-1-2:2007 (third edition)
- FCC CFR47Part15b ed IC (Industry Canada)
- ETSI EN301489-1e3V

Portable and mobile RF communications equipment can affect the behavior of the E4. The E4 needs special precautions regarding EMC and needs to be installed according to EMC information.

Use Condition

Ambient - E4 can be used in domiciliary settings, indoor or outdoor; it's resistant to water but cannot be immersed in water, can be lost by subject during use, should be worn tight to the wrist.

Light condition - 100-500lx, Visual distance: 20-40 cm, Visual angle +-90°

Environmental condition - Temperature -10°C +40°C, Relative humidity 20% - 95%, Air pressure - 500hPa to 1200hPa, Acoustic level - not relevant

Use frequency - It is extremely variable depending on subject/practitioner prescription:

Repetitive use (once per day) or prolonged use (few minutes to 40hrs).

MR Environment - The Empatica E4 has not been evaluated for safety and compatibility in the MR environment. The Empatica E4 has not been tested for heating or migration in the MR environment.

EMC Environment

Immunity Test	EN 60601-1-2: 2007 Test level
Electrostatic discharge (ESD) EN 61000-4-2	6 kV contact 8 kV air
Power frequency (50/60 Hz) magnetic field EN 61000-4-8	3 A/m
Conducted RF	Not applicable because of USB cable length < 1m
Radiated RF	3 V/m, 80 MHz to 2.6 GHz.

Real Time data streaming - The E4 realtime app is not intended to be used for remote real time patient monitoring. The real time data transfer happens only between the device and the smartphone while being in the connection range.

B. GENERAL AGREEMENTS

Empatica E4 wristband is intended for use in research settings; therefore we distinguish the Customer, who is usually a researcher managing a group of devices for use in a study, and the User, who is usually a research participant wearing Empatica devices.

The purchase of an Empatica device is subject to a purchase agreement between Empatica and a legal entity that acquires the product, namely the Customer. The Customer is responsible for the maintenance of the Empatica products and their proper use. Empatica is not responsible for any damage caused by improper use of the device.

The Customer is responsible for making sure that Users are fully informed and have consented before participating in any studies. The Customer is responsible for keeping safe any personal information of study participants or Users.

Empatica does not handle any personal information linked to physiological data on its servers; all physiological data will be de-identified. Data is organized by Sessions that have a start time and duration.

Empatica retains the right to update the existing products (E4-Firmware, Empatica connect, E4 realtime application and E4 manager) in order to improve quality and reliability. Users will be notified in case of an available update and will have the option to upgrade the product or to keep the version they have. Documentations will be periodically updated and distributed from the Empatica web including changelogs for each products.

This document is used for the sole purpose of supporting both the Customer and the User. It contains all the information that is useful for the correct use of the device and its maintenance. The present manual should be read carefully. The Customer and User must strictly adhere to the rules it contains.



Empatica S.r.l is not responsible for damages inferable to the final user, customer and person or animal that are due to improper use of the device.

C. MANUFACTURER DETAILS

Produced by:	<i>Empatica S.r.l</i>
Street:	<i>Via Stendhal 36</i>
City:	<i>Milano (MI)</i>
Cap:	<i>20144</i>
Tel:	<i>+39 02 36566473</i>
Fax:	<i>+39 02 36566473</i>
C.F.:	<i>07462810966</i>
EROI:	<i>IT 07462810966</i>
Website:	<i>www.empatica.com</i>
Support:	<i>support@empatica.com</i>
Commercial name:	<i>E4 fam device for physiological signal monitoring</i>
Models:	<i>E4</i>
Commercialization year:	<i>2015</i>

Empatica S.r.l may be referred to as Empatica or the Manufacturer.

D. USER TYPES

Personal use: *In this scenario the patient and operator are equivalent.*

The patient uses the E4 as a monitoring tool.

Professional use: *In this scenario the E4 is prescribed by a medical professional to a patients in order to monitor their physiological data and conduct studies on those data.*

The operator is the trained medical practitioner, while the patient is the person that will be monitored.

E. PRODUCT LABELING INFORMATION

The E4 labeling system is compliant with the requirements outlined in EN ISO 13485:2016/AC:2018, Medical Device Directive 93/42/EEC, 21 CFR 801 and 809.10.

Each device is identified by:

- Manufacturer name “Empatica” and logo  embossed at the end of the strap.
- Product Name: E4
- Serial number composed of one alphanumeric character followed by a 5-digit number, e.g. A00001, that uniquely distinguishes each device.

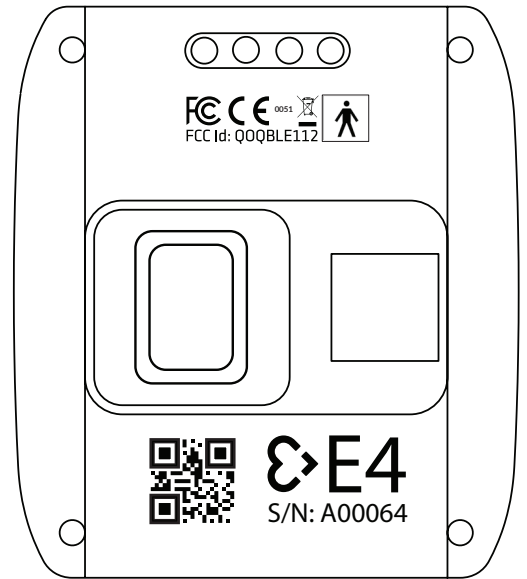

Most of the labeling information is laser printed on the bottom cover of the device. We also included the following marks denoting compliance to their corresponding standards:

Regulatory compliance:

- CE mark of conformity to the Medical Device Directive 93/42/EEC, Class IIa
- FCC CFR 47 Part 15b
- IC (Industry Canada)
- RoHS
- MIC Japan: ID R 209- J00046

Laboratory tests:

Electromagnetic compatibility

- IEC 60601-1-2:2014 (fourth edition)
- FCC CFR 47 Part 15b ed IC (Industry Canada)
- ETSI EN 301 489-17 V2.2.1

Safety

- IEC 60601-1:2005 (third edition)
- IEC 60601-1-11:2010 (first edition)

Usability

- IEC 60601-1-6:2010 (third edition)

¹Empatica devices have an integrated Bluetooth® module from which the FCC id is inherited

Package labeling and symbols description:

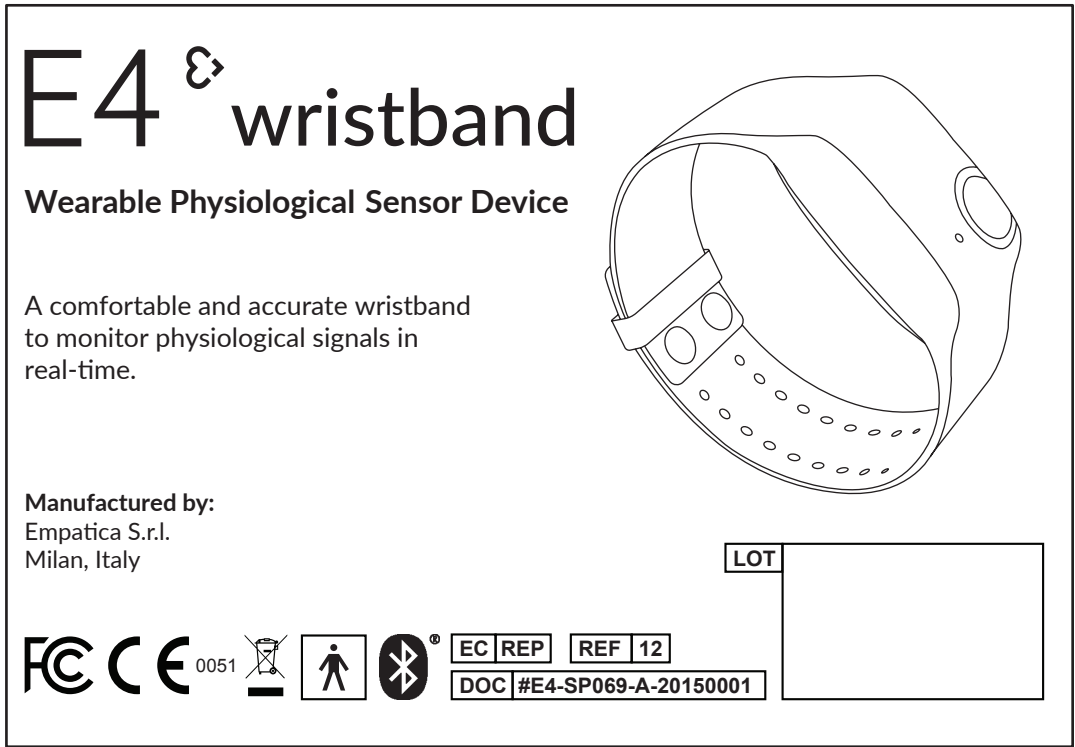



FCC Represents compliance of E4 product with the Federal Communications Commission of United States.

CE 0051 Represents compliance of E4 product with the European Community directive on medical devices 93/ 42/EEC.
Unique identifier of Notified body that certified the E4 product.

 Compliance of the E4 product with the Waste Electrical and Electronic Equipment Directive.

 E4 has two metal contact points that are used by the EDA sensor. This is type BF part which means that it may generate a leakage current when in contact with the skin. ISO60601-1 safety test demonstrated that this part is safe.

 To indicate that E4 intentionally generates RF signals for data transmission to a connected device.

 The E4 wristband uses Bluetooth® Low Energy to transfer data.

F. WARRANTY AND SUPPORT

The E4 is covered by warranty as stated by the general sale terms, where the modalities are described by which a broken or defective device can be returned to Empatica. If a malfunction arises during the warranty coverage period and the malfunction belongs to one of the categories listed in the warranty statement, Empatica, after a proper test of the device, will replace or repair it. Any intervention on the device done without the explicit indication by Empatica will void the warranty and Empatica will not be responsible for any damage to the modified product.

Issues NOT covered under warranty

- Damage to the main device case.
- Scratches or damage to the PPG sensor lens.
- Damage to the wristband containing the EDA electrodes caused by pull, torsion, or rotation of the band.
- Any issue in which the main case has been opened.

Issues covered under warranty

- Manufacturing defect at unpacking time.
- Manufacturing defect happened during device use.
- Significant battery issues (50% of declared battery within year).



Do not open the E4 case. Opening the E4 case will void the warranty.

Support and frequently asked questions (FAQ)

The user is advised to check the Empatica support portal section at:

<http://support.empatica.com/hc/en-us> for any issues related to the product.

This is the quickest way to receive help and common questions are addressed there. If no solution is available to the problem, the user is advised to contact customer service at support@empatica.com, which opens a ticket within Empatica's support system and issues a receipt to the Customer. A member of the support team will reply by email. If further assistance is required the user might be asked to engage in a live call or video conference for direct support. Once the issue has been resolved the support representative will close the ticket and the Customer will receive a notification.

Return merchandise authorization (RMA)

If Empatica support representatives are unable to resolve an issue remotely, an RMA will be issued. The Customer must fill in the RMA form and follow the instructions provided to return the product to Empatica for servicing. Empatica will not be responsible for returned merchandise without an executed RMA form.

Transport and Handling

The E4 is shipped in a carton box, which can be recycled after the unpacking. Each carton box may contain one or more devices which are stored inside their original plastic box.

When the E4 is not in use it's advised to place it inside its original plastic box to prevent any accidental damage.

The E4 can be stored in its original box for a maximum of 1 month without charging.

If the E4 will not be used for a longer time we recommend charging the device at least once a month.

Transportation can be performed inside its original package or can be worn on the wrist like a normal watch.

Disinfection before use

The E4 is designed to be suitable for repeated use by multiple Users. The Customer must ensure that the device is properly disinfected before being transferred between individual Users to prevent the transmission of skin diseases. This procedure is outlined in Chapter 8 of this manual under the "Cleaning and Disinfection" section.

Proper storage after use

The E4 should be properly stored. Not exposed to direct sunlight, moisture, humidity or rain.

Product disposal

Dispose of the E4, the E4 battery, and the USB cable in accordance with local regulations. Do not dispose of the battery with regular household waste. Recycle you package in accordance with local regulations.

Use with other accessories (i.e. battery charger)

It's forbidden to use the E4 with other accessories, unless normally approved by Empatica.

In particular it's forbidden to plug the E4 in any charger that is not complian with IEC 60950-1.

Use with children

The E4 does not require any particular safety procedure when used with children.

1. PACKAGE CONTENTS

The package of E4 contains:

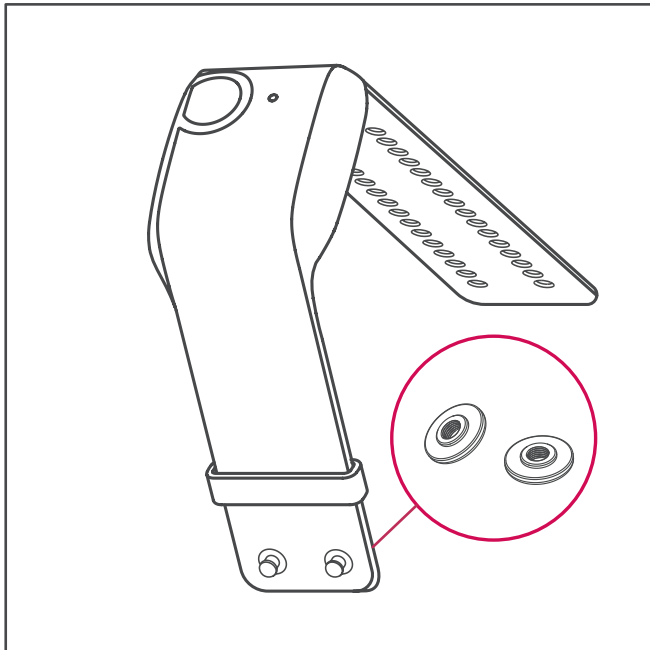

1 E4 wristband - adjustable size
1 pair of silver (Ag) plated electrodes (installed)

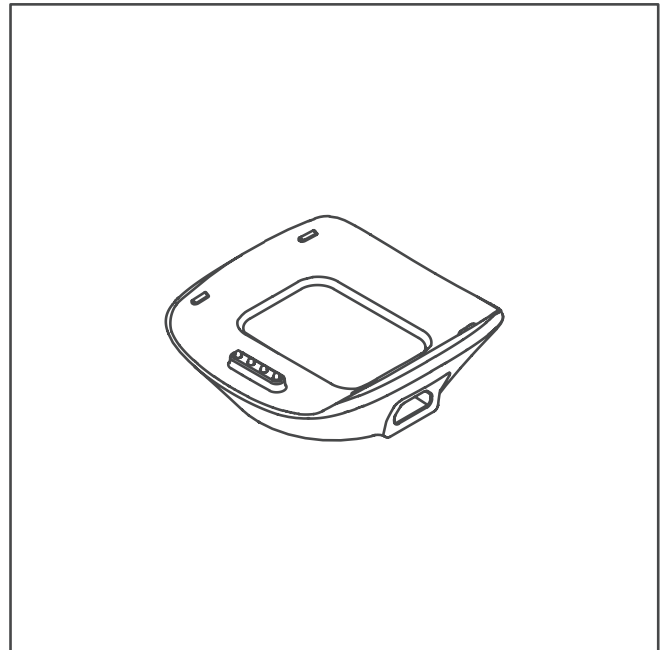

1 USB dock (for charging and data transfer)

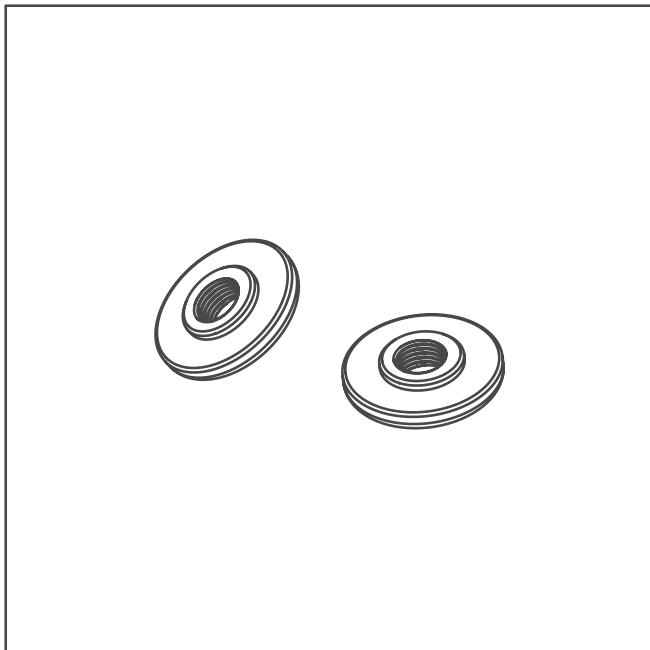

1 pair of silver (Ag) plated replacement electrodes

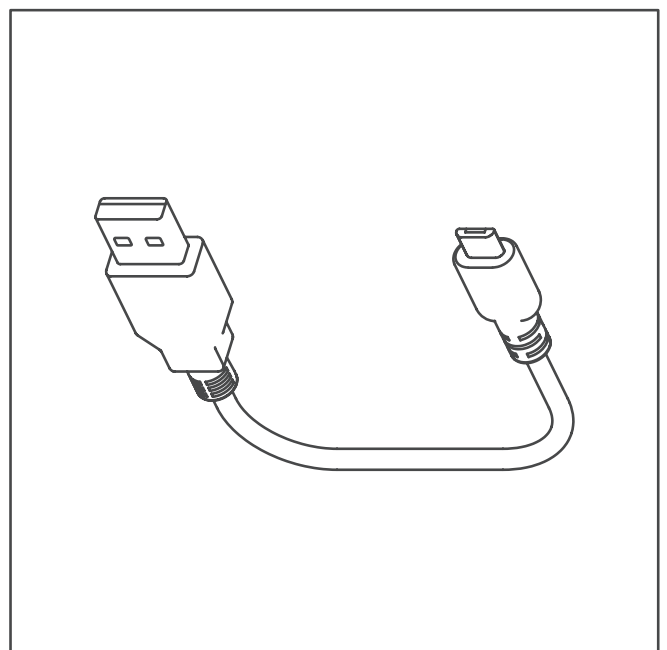

1 USB cable (type MICRO-B)

Package covers with Empatica Logo, Quick Start Guide and Certifications

2. E4 WRISTBAND OVERVIEW

The E4 is worn like a wristwatch. All of the sensors are embedded in the device: the PPG sensor and the temperature sensor are on the bottom side of the device while the wristband holds the EDA electrodes. The E4 is water resistant but it should not be submerged in liquids.

The picture below depicts an overview of the features of the E4:

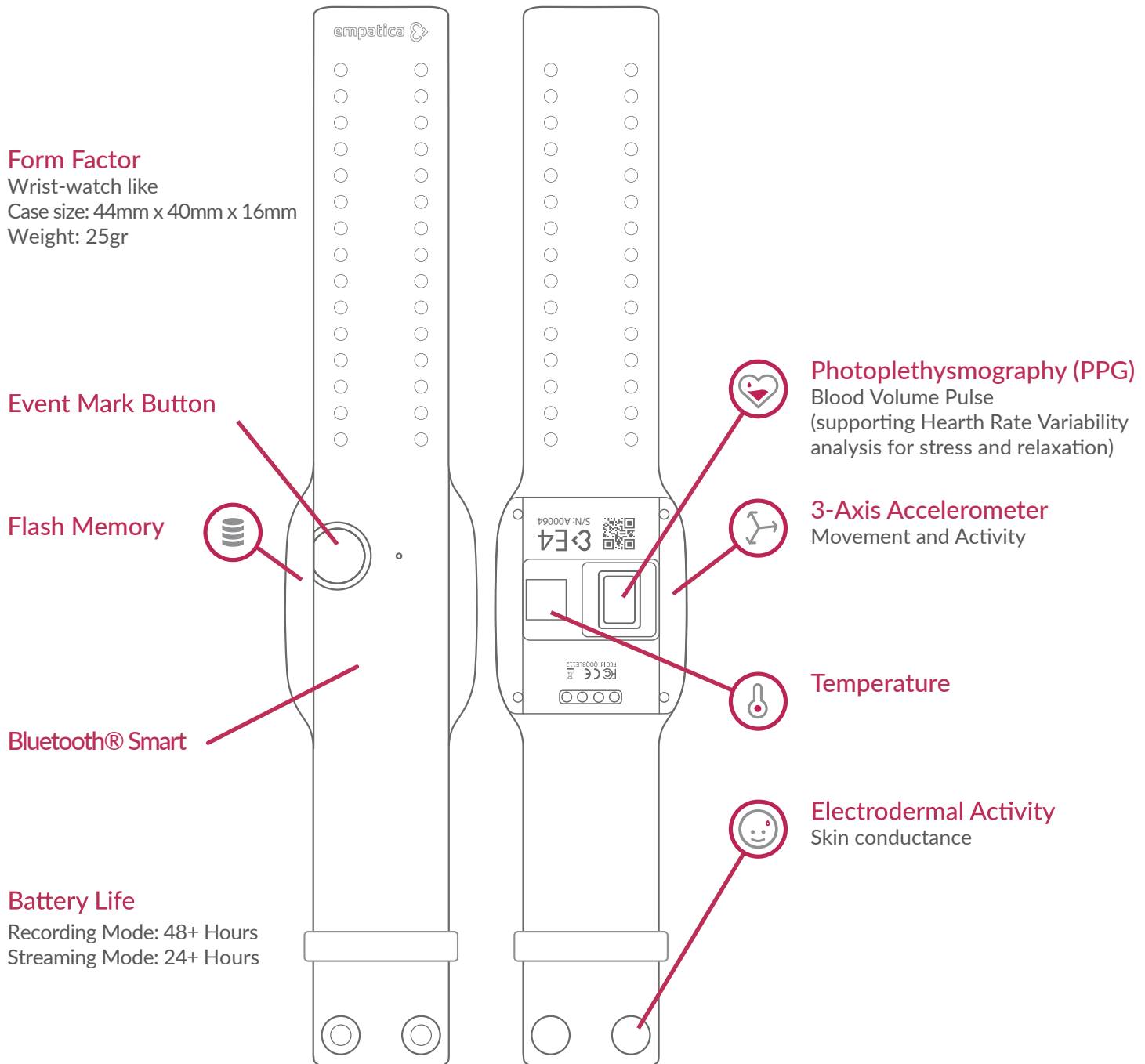

2.1 TECHNICAL SPECIFICATIONS

The user should refer to the Technical Specification document to have a better overview. Below we will review only the main technical specifications.

The expected life of the device depends mainly on the battery life which is 2 years.

PPG sensor

- Sampling frequency 64 Hz (Non customizable).
- LEDs: Green (2 LEDs), Red (2 LEDs) Photodiodes: 2 units, total 15.5 mm² sensitive area.
- Sensor output: Blood Volume Pulse (BVP) (variation of volume of arterial blood under the skin resulting from the heart cycle).
- Sensor output resolution 0.9 nW / Digit.
- Motion artifact removal algorithm:
 - Combines different light wavelengths.
 - Tolerates external lighting conditions.

EDA sensor

- Sampling frequency: 4 Hz (Non customizable).
- Resolution: 1 digit ~900 pSiemens.
- Range: 0.01 μ Siemens – 100 μ Siemens.
- Alternating current (8Hz frequency) with a max peak to peak value of 100 μ Amps (at 100 μ Siemens).
- Electrodes:
 - Placement on the ventral (inner) wrist.
 - Snap-on silver (Ag) plated with metallic core.
 - Electrode longevity:
 - 4–6 months

Infrared thermopile

- Sampling frequency: 4 Hz (Non customizable).
- Range:
 - -40...85°C for ambient temperature (if available)*.
 - -40...115°C for skin temperature.
- Resolution: 0.02°C.
- Accuracy \pm 0.2°C within 36-39°C.

Water resistance:

- IP 22 - E4 is protected against insertion of fingers and will not be damaged or become unsafe if exposed to vertically or nearly vertically dripping water.

E4 operating range:

- Relative Humidity 60 \pm 25% H.R.

3-Axis accelerometer

- Sampling frequency: 32 Hz (Non customizable).
- High sensitivity motion detection across 3 axes: X,Y, and Z.
- Default range \pm 2g.
- Ranges of \pm 4g or \pm 8g are selectable with custom firmware.
- Resolution: 8 bits of the selected range.

* This is not generally available but can be turned on with custom engineering work.

Battery power supply and battery:

- Charging cradle with E4 charging interface and standard Micro-B USB port.
- USB port, 5V, 250mA minimum supply
- Charging time: <2 hours.
- Battery Life in recording mode: >48 hours.
- Battery Life in streaming mode: >24 hours.
- Battery capacity: 300mAh
- Battery manufacturer: YJ Power
- Charging cycles: 500
- Life expectancy: 2 years
- Fully charge the E4 battery at least once a month for optimal performance. When the device is stored inside it's original box.

Real-time clock

Recording Mode:

- 5s synchronization resolution in recording mode.
- Average of 6 seconds in 6 million seconds drift.

Streaming Mode:

- Temporal resolution up to 0.2 seconds with connected device.

Memory

- Session data is approximately 1MB per recording hour.
- Device storage capacity exceeds 60 recording hours.

Hardware operating conditions

- Relative humidity: 0-100% H.R.
- Admitted air pressure: 100KPa ÷ 35Kpa.

E4 size

	mm	inches
• Max band circumference	190	7.48
• Min band circumference	110	4.33
• E4 Case length	44	1.73
• E4 Case width	40	1.57
• E4 Case height	16	0.63

Charger size

	mm	inches
• Charger length	45	1.77
• Charger width	44	1.73
• Charger height	12	0.47

Materials

- Band: polyurethane.
- Case: 70% polycarbonate + 30% glass fiber.
- Lenses: polycarbonate.
- Electrodes: silver (Ag) plated.
- Charging terminals: gold (Au) plated.

Bluetooth LE®

- Operating range: 10 meters
- Real time data streaming may be delayed by 1 sec.

Population

- Above 5 years old wrist circumference of 10 cm
- Skin: white to black, normal perfusion
- Light condition: any
- Use condition: static & motion, continuous monitoring

Weight

- 40 grams | 1.41 ounces.

2.2 BIO COMPATIBILITY

The E4 has the following set of components which can be in contact with the skin.

1 Temperature Sensor

- Silicon

2 PPG Sensor

- Polycarbonate (LG-SC1004A)

3 USB Terminals

- C3604BD(BC), Au Plated

4 Bottom Cover

- Polycarbonate (SDI-EH3300HF-K2115)
- Glass Fiber 30%

5 Top Cover

- Termoplastic polyuretane, SONGWON S185A

6 Electrodes

- Silver coated with copper underlay on brass

7 Loop Band

- Termoplastic polyuretane, Dow Corning EG4200

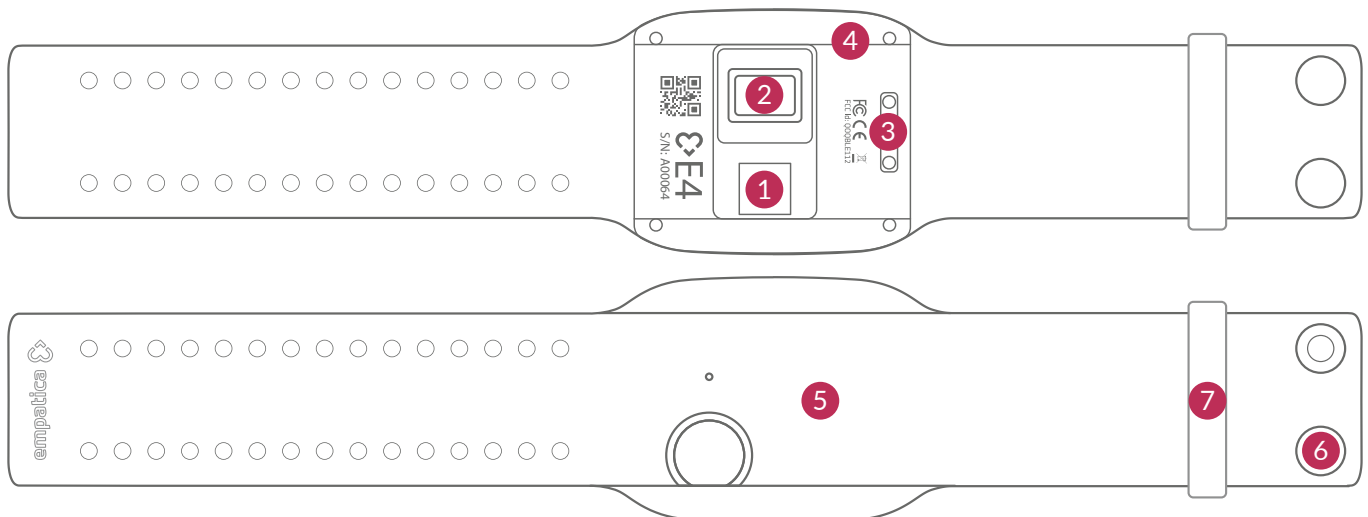

Precautions of use

It's forbidden to use the E4 with injured skin or other types of skin diseases located in the area where you plan to wear the E4.

Known allergic reactions

Among all E4 users (thousands) we have been reported with two cases of allergic reactions of light intensity (few days of persistence). Those people were also allergic to other types of substances. Please contact immediately our support team for any issue related to this topic.

During summer, the mechanical interference between the E4 band and the skin may cause the skin to become itchy. This is not related to any allergy but if this happens we suggest pausing the use of the device for a few hours.

3. BATTERY CHARGING

The E4 must be charged using a standard 5V USB 2.0 power source. In order to charge the device you have to use the charging dock provided from Empatica. Connect the included USB cable to the Micro-B port of the charging dock, connect the charging dock to the E4, and then plug the USB cable into the power source.

Charging dock and USB cable

The charging dock is only used while charging the E4; remove it before wearing the device. It is a passive component and it is not water resistant.

The charging dock has 4 metallic contacts that match the ones on the E4. Make sure to properly connect the charging dock, otherwise the charging process will not start.

Remember to remove the dock from the E4 before wearing the E4.

Charger

You can use a standard 5V USB charger with

the E4 such as the following:

- Chargers provided with mobile phones.
- Computer USB port.
- USB hubs (powered or un-powered).

Note that the charger should provide at least 250 mA (0.25 A) of current output for an optimal charging time.

Charging time

Charging times depend on how drained the battery is and on the current provided by the charger. Typical charging time with daily use is between 1 and 2 hours.

Charging E4 wristband

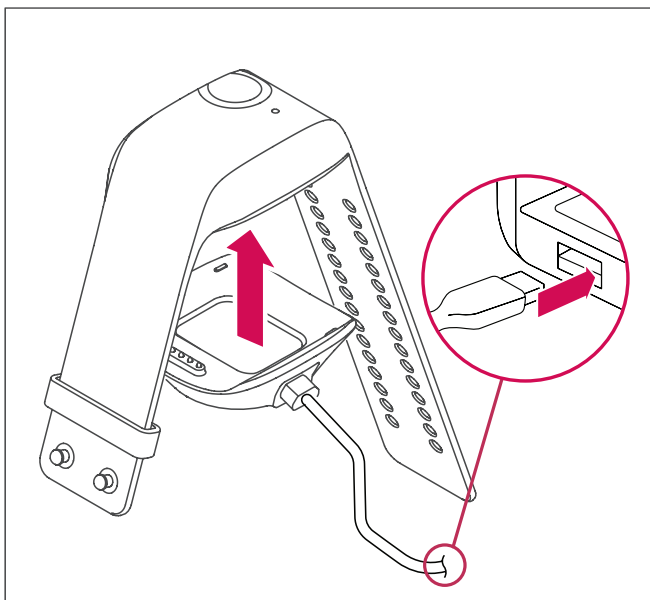

1 - Snap the E4 into the dock and affix the dock via USB to a power source.

2 - The LED will turn YELLOW indicating it has received power and is charging.

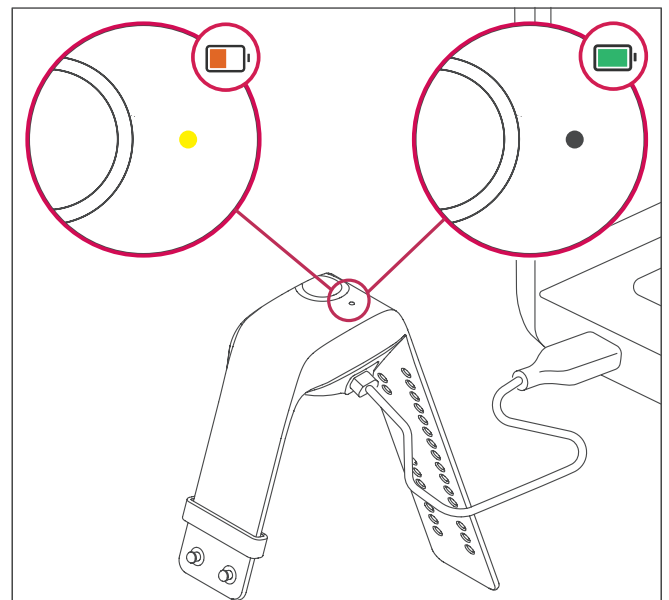



3 - When E4 is fully charged, the LED will turn a solid green.

Charge indicator LED lights

ACTION	WHAT TO DO	WHAT YOU SEE	NOTES
Charging the E4	Snap the E4 into the dock and affix the dock via USB to a power source. The LED will turn YELLOW indicating it has received power and is charging. When the E4 is fully charged the LED will turn a solid GREEN.		If the E4 Manager is running, the E4 will display alternating yellow and blue lights while charging, and when fully charged the sequence will change to green and blue.

Low battery indication

Low battery level is indicated with a yellow color i.e. 

WHAT YOU SEE ON E4	WHEN YOU SEE IT	WHAT IT MEANS
	After powering on the E4 and it is unplugged.	Very Low battery level.
	During recording.	Low battery level.
	During streaming.	Low battery level.

The only way to see the battery level of the E4 is to put it in streaming mode. The battery level can be viewed in the E4 realtime app.

4. WEARING THE E4 WRISTBAND

Wearing the device is as easy as wearing a watch.

Wear the E4 with the case on top of your wrist. Wear it snugly, so that it does not move around, but not so tight that it is uncomfortable.

Which side should you wear it on? Traditional recommendations are to record EDA on the non-dominant side to minimize motion artifacts (e.g. a right-hander would wear it on their left wrist). However, recent studies show that the dominant side may have a much stronger EDA signal during certain kinds of stress. Also, neurological events (such as seizures) may elicit EDA on only one side. (For more information see: [Picard, R. W., Fedor, S., & Ayzenberg Y., "Multiple Arousal Theory and Daily-Life Electrodermal Activity Asymmetry" Emotion Review, March 2015.](#)). Depending on your purposes, you may want to measure on the right, left, or both wrists.

The E4 button may be positioned on the same side as the thumb or on the other side – either orientation works fine.

The EDA electrodes (under the snaps) should be on the inside of the wrist. You may optionally line them up with a finger, e.g. the third (ring) finger, but this is not required.

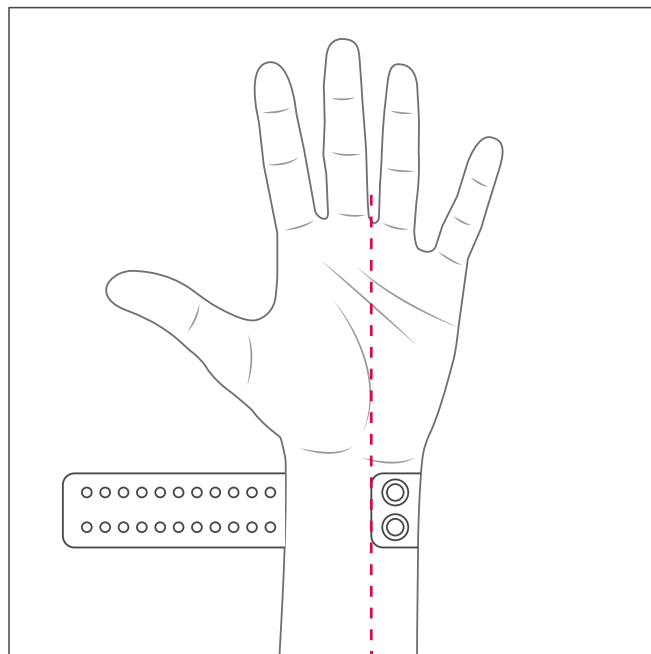
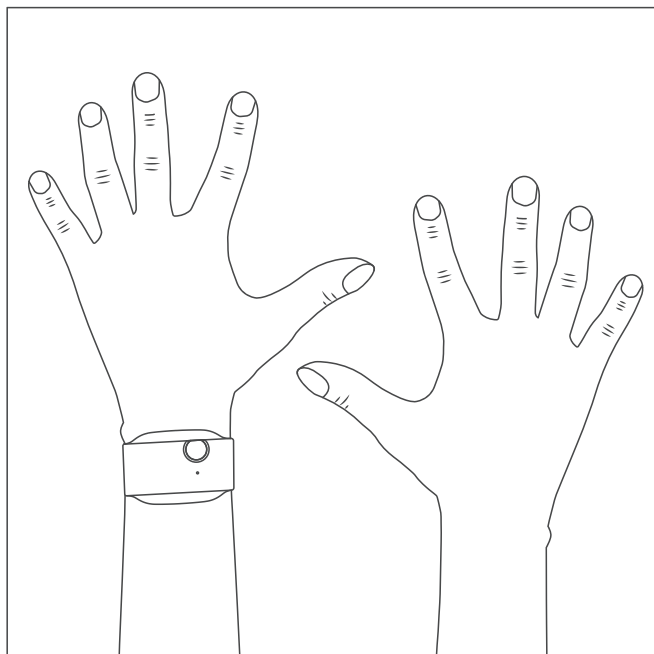

The quick start guide can also be found online at <https://www.empatica.com/get-started-e4>

Attaching the band

Follow these steps to attach the band:

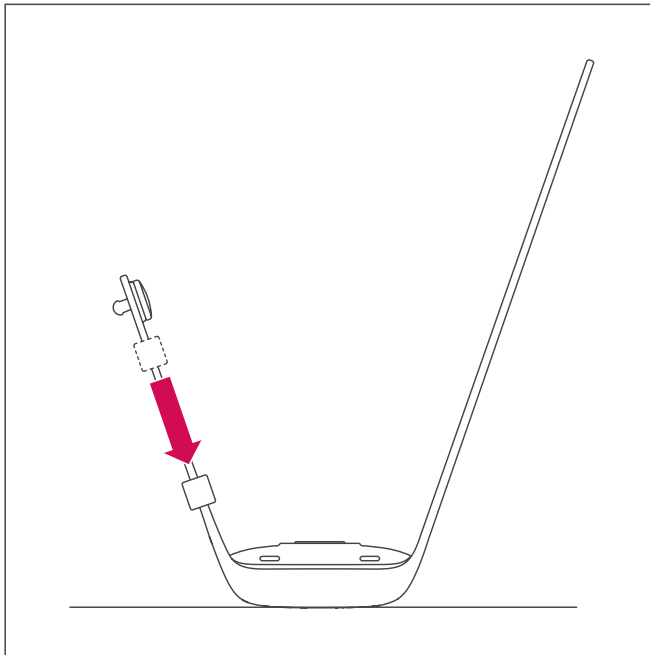

- 1 - Slide loop towards the case.
- 2 - Place the E4 top-down on a surface.

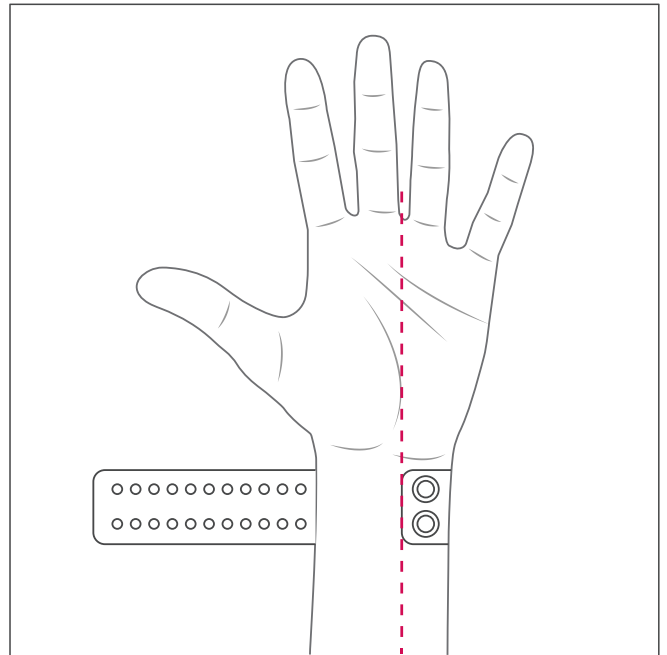

- 3 - Wrap the band around the wrist.
- 4 - Line up the snaps under the middle and ring fingers.

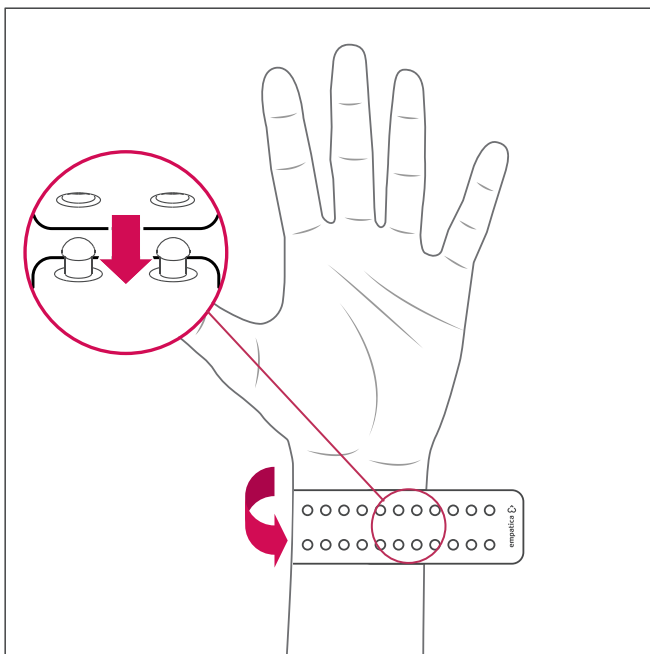

- 5 - Wrap the band over snaps and tighten.
- 6 - To secure, connect one snap at a time.
- 7 - If too tight, loosen by one snap.

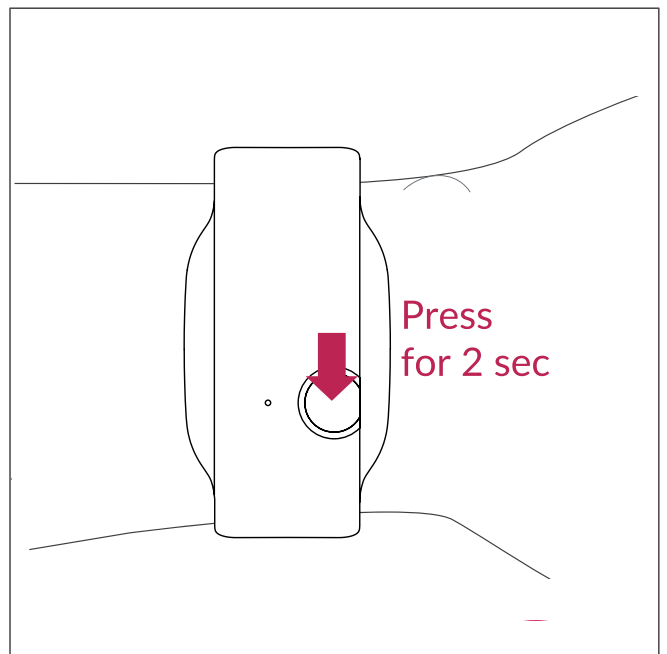

- 8 - The E4 should fit snugly above the wrist joint.
- 9 - Press the button to power on the E4.

5. INTERACTING WITH THE E4

Button and LED indicator light

The E4 is controlled with a push button interface **1**.
Status is viewed from the E4's multi-color LED indicator light **2**.

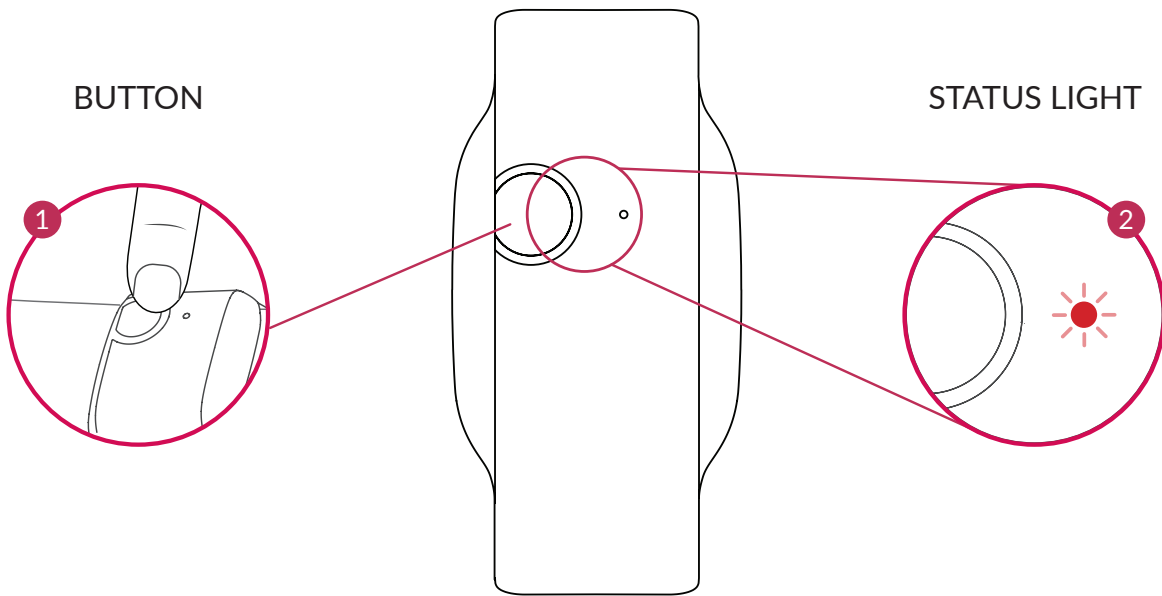

Button interactions

The E4's push button interface will trigger different actions depending on the duration of the button **1** press.

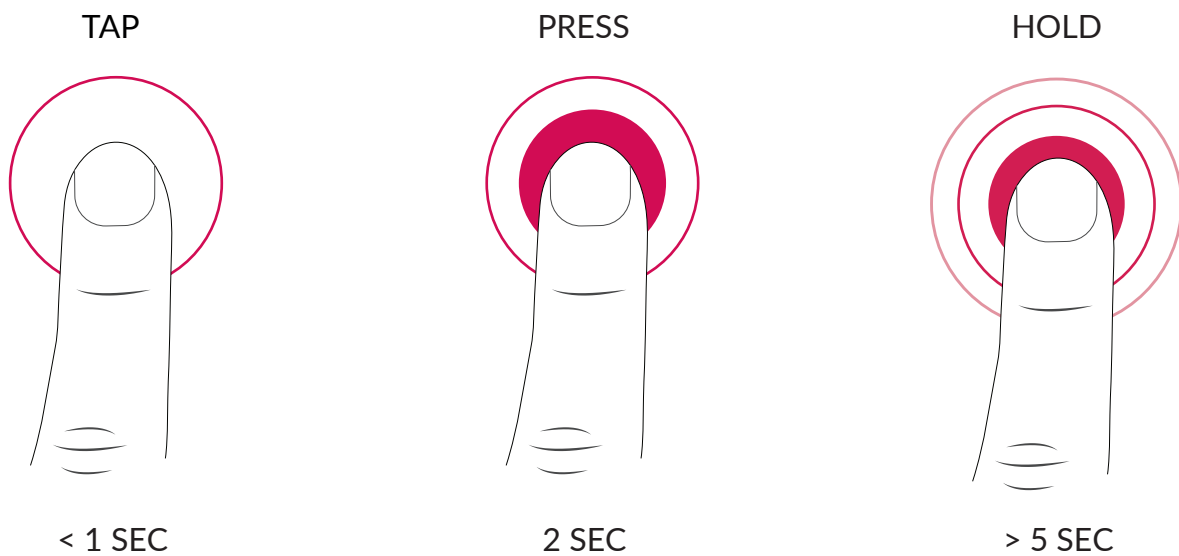

Tap the button to tag an event while recording.
The light will come on for 1 second indicating a tag has been registered

Press the E4 button to power on/off.
The E4 records automatically 40s after powering on.

Hold the button to reset your E4.
i.e. Use it when updating the firmware.

LED status interactions

The E4's LED light **2** will generally appear BLACK.



- Yellow light indicates the battery is charging (when the E4 is worn).
- Alternating yellow and blue lights signify that the battery is charging, while connected to E4 manager.
- A fixed yellow light indicates the battery is charging when attached to a power source.
- A blinking blue light is displayed whrn E4 is turned on.
- A steady red light indicates recording has started.
- A steady blue light indicates streaming has started.

When tagging an event (1 second press on button), a red light (recording mode) or blue light (streaming) will appear for 3 seconds.

*Note: During sessions the light powers off after 40 seconds to save power.

6. USING THE E4 WRISTBAND

Creating an Empatica connect account

Create a Customer account on Empatica connect to start using the E4.

1. Navigate to the connect Login Page: <https://www.empatica.com/connect/>
2. Click on the “Create Account” tab.
3. Fill in all the required fields and then press the “Create Account” button.
4. A confirmation email will be sent to the address provided. Follow the instructions in the email to activate the account before you attempt to login.





Working in streaming mode

Install the E4 realtime app on your Bluetooth(R) Smart ready iOS or Android device (search for “E4 realtime” in Google Play or the App Store).

Once installed, connect the E4 with a mobile device using E4 realtime app to:

- View sensor data in real time.
- Easily zoom and pan to check your signals.
- Automatically upload data to your Empatica connect account after a session ends.

Start streaming with the E4:

ACTION	WHAT TO DO	WHAT YOU SEE
Prepare your phone	Make sure Bluetooth® is enabled on your compatible device.	
Launch E4 realtime App	Open the App on your mobile device and login using your Empatica account.	
Power ON the E4	When the device is powered off a 2-sec button press will power it on.	
Start streaming	Click “Connect E4 and Start Recording” and select your E4 from the list. The E4’s indicator light blinks blue before fading.	
Tag an event	Tap the button (<1 sec) while streaming to tag an event. *Be careful to click and release quickly when entering a tag to avoid powering down or resetting the device.	
End session	Tap the “Stop Recording” button on the home screen. The E4 powers OFF and the session uploads to “empatica connect”. The E4 will also power off if the Bluetooth® connection is lost, e.g. is out-of-range. Warning: When your device goes out of range while in streaming mode, it will stop recording data.	

The latest information on E4 realtime, including frequently asked questions and trouble-shooting tips, is on the Empatica support portal: <http://support.empatica.com/>

Working in recording mode

For easy everyday use of the E4 you can record data on the go and sync it once a day.

Recording mode allows you to record data and analyze it later.

Download E4 manager from <https://www.empatica.com/product-e4-download> and follow the installation instructions.

Once installed, use E4 manager to synchronize your session data to Empatica connect, set the E4's clock and manage device firmware.

Start recording with the E4 wristband:

ACTION	WHAT TO DO	WHAT YOU SEE
Set the clock	<ol style="list-style-type: none"> 1. Launch the E4 manager application on your computer. 2. Login with your "empatica connect" credentials. 3. Connect the E4 to the computer; the E4 manager will setup your device and synchronize the internal clock with the computer's clock. 4. Unplug the E4 from the USB. 	<p>alternating</p>
Power ON the E4	When the device is powered off a 2-sec (standard) button press will power it on.	<p>off → pulsing</p>
Wait for recording to begin	The device will enter Bluetooth® Discovery Mode before starting to record. It will wait 40 sec for a possible wireless session to start. When no Bluetooth connection is established in 40 seconds, then the E4 starts to log data to its onboard memory and a steady red light appears. After 20 seconds, the LED turns off to save power.	<p>pulsing → steady → off</p>
Tag an event	Tap the button (<1 sec) while streaming to tag an event. *Be careful to click and release quickly when entering a tag to avoid powering down or resetting the device.	<p>1 pulse</p>
End session	A 2-sec button press powers it off, stopping the recording, and marking an end of file for the data record.	<p>1 pulse</p>
Upload session data	Download the recorded data by opening the E4 manager on your computer and plugging the E4 device into the USB port using the charging dock and USB cable.	<p>pulsing</p>
Power OFF the E4	Power off the E4 with a 2-second button press (from any powered-on state).	<p>any color → off</p>

The latest information on E4 manager, including frequently asked questions and trouble-shooting tips, is on the Empatica support portal: <http://support.empatica.com/>

Access your web dashboard



Login to your Empatica connect account at <https://www.empatica.com/connect/>

- View, manage, and download all of your E4 sessions through the Empatica connect web dashboard.
- View session details by time series for each signal type (EDA, BVP, HR, TEMP and ACC) with event mark tags overlaid.
- Download raw data in CSV format for easy processing and analysis in third party applications.
- Your data is secured with encryption and can be deleted after use.



The latest information on Empatica connect, including frequently asked questions and troubleshooting tips, is available at the Empatica support portal <http://support.empatica.com/>

7. FAULTY STATES

WHAT YOU SEE	WHAT IT MEANS	WHAT TO DO	NOTES
 pulsing light	Internal clock is wrong and needs to be synchronized. -or- Internal memory is full. -or- Internal memory is in a faulty state.	The User can solve the issue by plugging the E4 via USB and connecting it to the E4 manager.	Streaming functionality is still possible in this condition.
 pulsing light	Serious hardware problem that can not be recovered.	The device should be returned for repair following the RMA procedure outlined in the Warranty and Support section above.	No response from the button. No reset is possible.
 No LED light	Serious hardware problem that can not be recovered.	The device should be returned for repair following the RMA procedure outlined in the Warranty and Support section above.	No response from the button. No reset is possible.

If the device is not responsive or failing to behave as described above after powering off and let the Empatica Support team know by emailing support@empatica.com.

8. TAKING CARE OF YOUR DEVICE

Cleaning and disinfection

The E4 and all its accessories were been cleaned before shipment but must be considered all non-sterile.

Before switching between Users, and it is recommended that every week, carefully clean all parts of the device that come in contact with the skin. The disinfection processes should include one or more of the following methods:

- Exposure to UV lamp.
- Cleansing with cotton soaked with a small quantity of ethyl or isopropyl alcohol.
- Cleansing with a solution containing Alkyl C12-16 Dimethylbenzyl Ammonium Chloride.

Do not use cleaning agents other than those described above without explicit written instructions from Empatica support.

Types of electrodes

The E4 comes with user-replaceable 8mm diameter silver (Ag) plated electrodes.

The Ag electrodes should last for months under continuous use but will oxidize, picking up a grey tarnish over time. The EDA electrodes should not be replaced frequently as screwing and unscrewing repeatedly may degrade the performance of the sensor. Reserve electrode replacement for end-of-life replacement of Ag electrodes or for electrode comparison studies. It is not necessary to change electrodes between Users. The disinfection process can be done when the electrodes are attached to the E4.

Replacing the electrodes

When necessary the E4 electrodes can be replaced by hand by snapping the old ones off and snapping the new ones on. If the electrodes cannot be removed easily then the attachment system may be damaged. Report any problems to support@empatica.com for further instructions.

The Empatica E4 has a 2-year expected lifetime, considering the correct conditions of use.

empatica s.r.l.

Via Stendhal 36, 20144 Milano (MI)
www.empatica.com
@empatica

#UM-16Rev.2.0 20201020

