

3D PRINTING HANDBOOK

USER MANUAL FOR 3D PRINTERS:

- ORIGINAL PRUSA i3 MK3S+ KIT
- ORIGINAL PRUSA i3 MK3S+

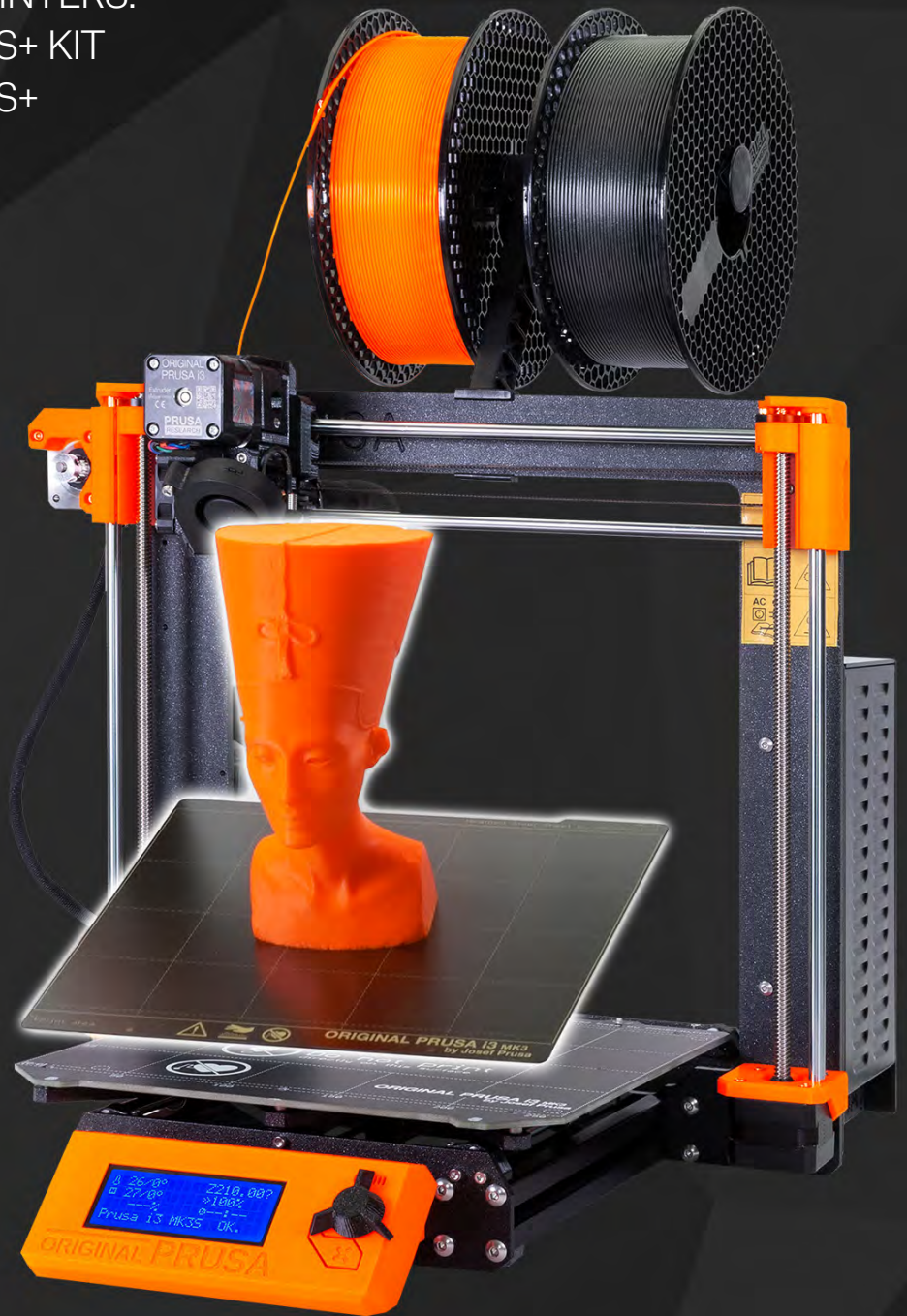

PRUSA
RESEARCH
by JOSEF PRUSA

Prusa Research a.s.
Partyzánská 188/7A
170 00 Praha
www.prusa3d.com
info@prusa3d.com



ENG

 Please always refer to the <https://www.prusa3d.com/drivers/> for an updated version of this 3D printing handbook (PDF download).

Translated versions of the handbook are available at: Czech: www.prusa3d.cz/ovladace/ | French: www.prusa3d.fr/drivers/ | German: www.prusa3d.de/treiber/ | Polish: prusa3d.pl/sterowniki/ | Italian: www.prusa3d.it/driver/ | Spanish: www.prusa3d.es/drivers-y-manuales/

 This handbook covers both Original Prusa i3 MK3S and Original Prusa i3 MK3S+ 3D printers with the latest firmware version installed. Always check if you have the latest firmware - see chapter [13. 9. Updating printer firmware](#)

QUICK GUIDE TO THE FIRST PRINT

1. Read the safety instructions carefully ([page 7](#))
2. Place the printer on a flat and stable surface ([page 10](#))
3. Download and install the drivers ([page 47](#))
4. Calibrate the printer by following our calibration flow / wizard ([page 12](#))
5. Insert the SD card into the printer and print your first model ([page 29](#))

 Important notice, tip, hint or information that helps you print with ease.

 Read carefully! This part of the text has the greatest importance - either for user safety or for proper printer service.

 This symbol indicates text related to a printer kit only.

How to contact our support: First, check the last chapters of this handbook for troubleshooting guides, or visit <https://help.prusa3d.com> for a complete list of common issues, print quality troubleshooting and other guides. If your problem is not listed there, or the solution does not work, please send an e-mail to info@prusa3d.com or use the Live chat at <https://www.prusa3d.com>. Try to explain your problem as thoroughly as possible.

JOSEF PRUSA®, PRUSA RESEARCH®, PRUSA POLYMERS®, PRUSA ORANGE®, ORIGINAL PRUSA®, PRUSA 3D®, and PRUSAMENT® are registered trademarks of Prusa Development a.s. in the United States and the European Union used under the license by Prusa Research a.s. | JOSEF PRUSA, ORIGINAL PRUSA, and PRUSAMENT are registered trademarks (or registration pending) of Prusa Development a.s. in Australia, New Zealand, Israel, Mexico, South Korea, Turkey, Ukraine, Russia, Kazakhstan, Switzerland, China, Columbia, Uzbekistan, Philippines, and Norway used under the license by Prusa Research a.s. | Other company names and product names appearing in this publication are the trademarks and registered trademarks of their respective companies.

About the author

Josef Prusa (born Feb 23rd, 1990) became interested in the 3D printing phenomenon before joining Prague's University of Economics in 2009 - at first, it was a hobby, a new technology open to changes and improvements. The hobby soon became a passion and Josef grew into one of the leading developers of Adrien Bowyer's international, open-source, RepRap project. Today, you can see the Prusa design in different versions all around the world, it is one of the most popular printers and thanks to it, knowledge about the 3D printing technology significantly increased among the public.

Jo's work on self-replicating printers (you can print the other printer parts with your printer) still ongoing and the latest model, Original Prusa i3 MK3S+, is currently on the market - it's an improved version of the original 3D printer's third iteration. It is constantly updated with the latest innovations and you've just purchased its latest version. In addition to printer hardware upgrades, the main goal is to make the technology more accessible and understandable to all users.

Josef Prusa also organizes workshops for the public, participates in professional conferences dedicated to the popularization of 3D printing. For example, he lectured at the TEDx conference in Prague and Vienna, at World Maker Faire in New York, Maker Faire in Rome or at the Open Hardware Summit hosted by MIT. Josef also teaches Arduino at Charles University and was also a lecturer at the Academy of Arts in Prague.

In his own words, he imagines 3D printers will be available in every home in the not-too-distant future. "If anything is needed, you can simply print it. In this field, you just push the boundaries every day... We're glad you're part of it with us!"



Table of contents

2 Product details	6
3 Introduction - Glossary, Disclaimer, Safety instructions, Licenses	6
4 Original Prusa i3 MK3S+ printer	8
5 Original Prusa i3 MK3S+ printer kit	9
6 First steps	10
6.1 Printer unpacking and proper handling	10
6.2 Printer assembly	11
6.3 Setup before printing	11
6.3.1 Calibration flow and wizard	12
6.3.2 Preparation of the spring steel sheet	13
6.3.3 Increasing the adhesion	18
6.3.4 Selftest (kit only)	18
6.3.5 Calibrate XYZ (kit only)	20
6.3.6 Calibrate Z	23
6.3.7 Mesh bed leveling	24
6.3.8 Loading the filament into the extruder	25
6.3.9 First layer calibration (kit only)	26
6.3.10 Fine tuning the first layer	29
7 Printing	30
7.1 Removing objects from the printer	30
7.2 Printer Control	31
7.2.1 LCD screen	31
7.2.2 Controlling the LCD screen	31
7.2.3 Print statistics	32
7.2.4 Fail stats	32
7.2.5 Normal vs. Stealth mode	33
7.2.6 Factory reset	33
7.2.7 SD card sorting	34
7.2.8 Testing if file (.gcode) is complete	34
7.2.9 LCD layout	35
7.2.10 Print speed versus print quality	37
7.2.11 USB cable and Pronterface	38
7.2.12 Power panic	39
7.2.13 Crash detection	40
7.2.14 Temperatures	40
7.2.15 Voltages	40
7.2.16 Safety timer	41
7.2.17 Beeper settings	41
7.2.18 Language settings	41
7.2.19 Dump memory	41
7.3 Printer addons	42
7.3.1 Different nozzles	42
7.3.2 Original Prusa Multi Material Upgrade 2S	43
7.3.3 Connecting Raspberry Pi Zero W	44
8 Advanced Calibration	45
8.1 Steel sheet profiles	45
8.2 Nozzle diameter setup	45

8.3 PID tuning for Hotend (Optional)	45
8.4 PINDA probe calibration / Temp. calibration (Experimental/Optional)	46
8.5 View XYZ calibration details (Optional)	46
8.6 Linear Advance	47
8.7 Extruder info	47
8.8 Sensor info	47
8.9 Display brightness	48
9 Printer drivers	48
10 Creating and printing your own models	48
10.1 Where can you get the 3D models?	48
10.1.1 Printables	49
10.1.2 Bundled 3D models	50
10.2 In what program can you create your own models?	50
10.3 Modeling with 3D printing in mind	51
10.3.1 Overhangs and support material	51
10.3.2 Fillet vs chamfer	51
10.3.3 Thin walls and minimum feature size	52
10.3.4 Splitting model into multiple parts	52
10.3.5 Tolerances	52
11 Slicing	53
11.1 PrusaSlicer	54
11.2 Printing of non-standard models	55
11.2.1 Printing with support material	55
11.2.2 Large object printing	55
11.3 Print in color with ColorPrint	57
12 Materials	59
12.1 PLA, PETG, ASA/ABS, PC Blend, Flex, CPE, Nylon, XT, HT, Composites, HIPS, PVA, nGen, PP, T-Glase	59
12.16 Creating profiles for new materials	68
13 FAQ - Printer maintenance and print issues	69
13.1 Regular maintenance	69
13.2 Print surface preparation	70
13.3 Filament sensor	70
13.4 Clogged / jammed extruder	72
13.5 Nozzle cleaning	73
13.6 Replacing / changing the nozzle	73
13.7 Printing problems	76
13.7.1 Layers break and split when printing from ABS material	76
13.7.2 Models contain either too much or not enough of the filament	76
13.8 Problems with finished models	76
13.8.1 Model breaks and/or is easily damaged	76
13.9 Updating printer firmware	77
13.10 Linearity correction	78
14 FAQ - common issues when assembling the printer kit	78
14.1 Printer is rocking - YZ frame - geometry check	78
14.2 Printer stops printing soon after start	79
14.3 Printer can't read the SD card	79
14.4 Loose X- and/or Y-axis belts	79
14.5 Cables detached from the heatbed	78
15 FAQ - Error messages	81

2 Product details

Title: Original Prusa i3 MK3S+ / Original Prusa i3 MK3S+ (kit), Filament: 1.75 mm
Manufacturer: Prusa Research a.s., Partyzánská 188/7A, Prague, 170 00, Czech Republic
E-mail: info@prusa3d.com
EEE group: 3 (IT and/or telecommunication equipment), Device use: indoor only
Power supply: 90-135 VAC, 3.6 A / 180-264 VAC, 1.8 A (50-60 Hz)
Working temperature range: 18 °C (PLA)-38 °C, indoor use only
Working humidity: 85 % or less

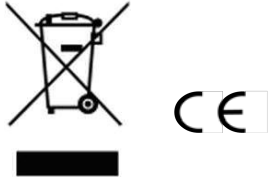

Kit weight (gross / net): 9.8 kg / 6.3 kg, assembled printer weight (gross / net): 12 kg / 6.3 kg.
The serial number is located on the printer frame and also on the packaging.

3 Introduction

Thank you for purchasing 3D printer **Original Prusa i3 MK3S+** from Josef Prusa either as an assembled printer or a printer kit - your purchase supports us with its further development. Please, read the handbook carefully, since all chapters contain valuable info for the correct service of the printer. **Original Prusa i3 MK3S+** is a successor to Original Prusa i3 MK2S with numerous hardware and software upgrades, which lead to improved reliability and ease of use and assembly.

In case of any printer-related problem, do not hesitate to contact us at info@prusa3d.com or via 24/7 live chat at prusa3d.com. We are glad to receive all of your valuable comments and tips. We also suggest you visit our official forum at forum.prusa3d.com, where you can find solutions to common issues, tips, advice and hints, in addition to actual information about the Original Prusa i3 printer's development.

3.1 Glossary

Bed, Heatbed, Printbed - The commonly used term for the printing pad - a heated area of the 3D printer where 3D objects are printed.

Extruder - The printing head also known as an extruder, is a part of a printer consisting of a nozzle, hobbed pulley, idler, and a nozzle fan.

Filament - The term for plastic provided on a spool. It's used throughout this handbook as well as in the LCD menu on the printer.

Heater, Hotend - Other names for a printing nozzle.

1.75 - 3D printers use two different diameters (thickness) of filament: 2.85 mm (commonly called as 3 mm) and 1.75 mm. Worldwide, the 1.75mm version is used more, although there is no difference in printing quality.

3.2 Disclaimer

Failure to read the handbook may lead to personal injury, inferior results, or damage to the 3D printer. Always ensure that anyone who operates the 3D printer knows and understands

the contents of the Manual. We cannot control the conditions in which you assemble the Original Prusa i3. For this, and other reasons, we do not assume responsibility, and expressly disclaim liability for loss, injuries, damage, or expense arising out of, or in any way connected with, the assembly, handling, storage, use or disposal of the product. The information in this handbook is provided without any warranty, expressed or implied, regarding its correctness.

3.3 Safety instructions



Please be very cautious during any interaction with the printer. This printer is an electrical device with moving parts and hot-temperature areas.

1. The device is for indoor use only. Do not expose the printer to rain or snow. Always keep the printer in a dry environment at a minimum distance of 30 cm from other objects.
2. Always place the printer on a stable place, where it cannot fall or tip over.
3. The printer supply is household power outlet 230 VAC, 50 Hz or 110 VAC / 60 Hz. Never connect the printer to a different power supply; it may cause malfunction or damage to the printer.
4. Place the power cord so you cannot stumble on it or step on it, or otherwise expose it to any potential damage. Also, make sure that the power cord is not mechanically or otherwise damaged. If so stop using the damaged power cord immediately, and replace it.
5. When you disconnect the power cord from the socket, pull the plug rather than the cord to reduce the risk of damage to the plug or to the AC outlet.
6. Never disassemble the printer power supply; it does not contain any parts that could be repaired by an unskilled worker. All repairs must be performed by a qualified technician.
7. Do not touch the nozzle or heatbed when the printer is printing or warming up. Note that the temperature of the nozzle is 210-300 °C (410-572 °F); heatbed temperature can reach over 100 °C (212 °F). Temperatures above 40 °C (104 °F) can cause harm to the human body.
8. Do not reach inside the printer while it is still in operation. An injury may be caused by its moving parts.
9. Prevent children from unsupervised access to the printer even when the printer is not printing.
10. Do not leave the printer unattended while it's still on! While the device has a number of safety features and temperature monitoring, incorrect wiring, damaged cables, failure of components, and/or failure to follow the instructions of this handbook may lead to a fire hazard.
11. Plastic is being melted during printing which produces odors. Set up the printer in a well-ventilated place.

3.4 Licenses

The Original Prusa i3 MK3S+ printer is a part of the RepRap project, the first open source 3D printer project free to use under a GNU GPL v3 license (www.gnu.org/licenses/gpl-3.0.en.html). If you improve or alter any part of a printer, and you are willing to sell it, then you have to publish the source code under the same license. All 3D-printed elements of the printer that can be improved upon can be found at <https://www.prusa3d.com/prusa-i3-printable-parts/>.

4 Original Prusa i3 MK3S+ printer

Unlike the printer kit, the printer comes completely assembled and almost ready to print. After plugging in, and running the necessary calibration, you can print a 3D object in a matter of minutes after unpacking the printer. Keep in mind, you can use our support email or live chat when you purchase the assembled printer. Do not hesitate to write to us if you need any advice or help. See the contact information on page 2.

 3D printers use two different diameters of filament: 2.85 mm and 1.75 mm (you can find more in the chapter *Materials*). The 1.75mm version is used more frequently worldwide, although there is no difference in printing quality. The filament is provided on a spool, which should feature a list of basic information - filament maker, material (ABS, PLA, etc.) and filament diameter. 2.85 mm filament is commonly called 3 mm.

This printer supports only a 1.75 mm filament. Please check that the filament diameter is 1.75 mm before inserting it into the extruder. Do not try to insert wider filament; it could damage the extruder.

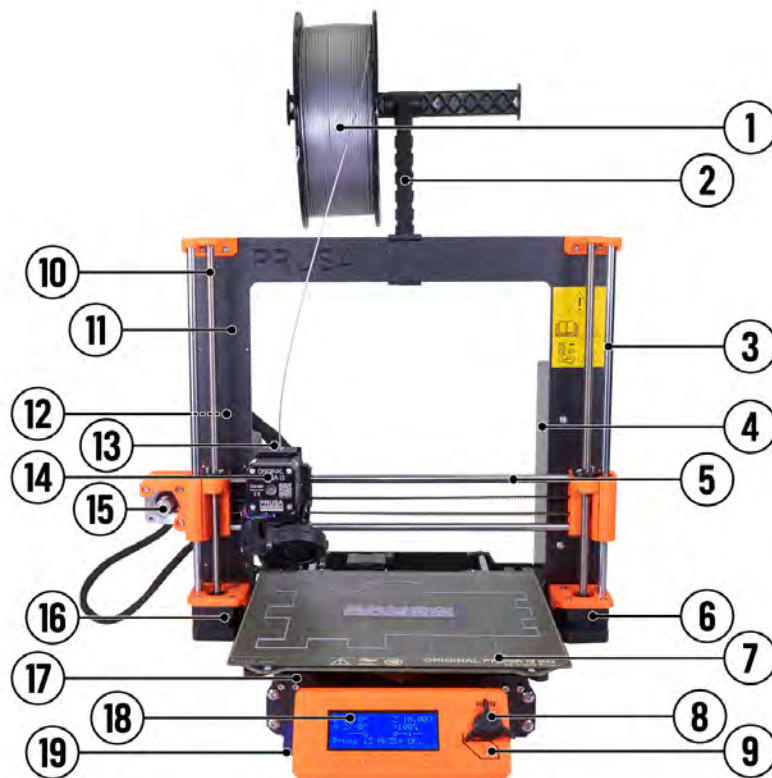

Pict. 1 - Original Prusa i3 MK3S+ printer description: (1) Filament spool; (2) Spool holder; (3) Z-Axis; (4) Power supply; (5) X-Axis; (6) Z2 Stepper; (7) Heatbed with spring steel sheet; (8) LCD Knob; (9) Reset Button; (10) Threaded Rod; (11) Printer Frame; (12) USB Port; (13) Einsy Rambo Board; (14) Extruder Stepper; (15) X-Stepper; (16) Z1 Stepper; (17) Y-Axis; (18) LCD Panel; (19) SD Card Slot

5 Original Prusa i3 MK3S+ printer kit



Original Prusa i3 MK3S+ kit is shown in pict. 2. Detailed information and assembly instructions can be found in chapter [6.2 Printer assembly](#). Keep in mind, you can use our support email or live chat when you purchase the kit. Do not hesitate to write to us if you need any advice or help. Follow the contact information on page 2.



Pict. 2 - Original Prusa i3 MK3S+ printer kit unboxed

6 First steps

6.1 Printer unpacking and proper handling

While holding the upper frame, take the printer and pull it out from the box. Be careful when handling the printer not to damage the electronics and thus the proper printer functionality. Any time you move the printer, always hold the upper frame with the heatbed horizontal to the ground, pointing away from you as pictured in pict. 3. When unpacking **the fully assembled version**, remove the top foam from the box and gently lift the printer up. Parts of the printer are secured by more foam which needs to be removed. Some parts are additionally secured with the white zip-ties, cut those off too.



Pict. 3 - Proper handling of the printer

Both the assembled version and the kit version come with a few things you might need during the printer use.

- **USB Cable** - used for uploading new firmware or alternatively printing from the computer.
- **Acupuncture needle** - used for cleaning a clogged nozzle. See chapter [13.5 Nozzle cleaning](#) for more information.
- **Glue stick** - Used for better adhesion of Nylon, or as a separator for Flex materials. See chapter [12 Materials](#) for more information.
- **Lubricant** - After a certain period of time (see the [Chapter 13.1 Regular maintenance](#)), your 3D printer should be cleaned and greased in order to work

properly. No need to apply this lubricant during the first assembly of the kit, all parts are greased by the manufacturer.

- **Tools and Spare parts** - Includes needle-nose pliers, a Phillips screwdriver, Allen keys and a package of the small spare parts (fasteners, magnets, PTFE tube).
- **IPA pads** - Several IPA pads to clean your print sheet.
- **Test protocol** - All the components of every printer are tested. The electronic parts are connected (as in a final assembly) and a battery of tests is run. The serial number stickers and the test protocol are printed only when the components pass all of the tests. The test protocol lists all the test results.

6.2 Printer assembly



For the Original Prusa i3 MK3S+ printer kit, we suggest following the guidelines and assembling the kit according to the online manual at help.prusa3d.com. (The online manual is available in several languages on the website). The construction of the printer should not take more than one working day. After successful completion, continue to chapter [6.3 Setup before printing](#).

6.3 Setup before printing

- Place the printer in a horizontally stable position; the best place is a workbench where there is no risk of a draft.
- Attach the filament holders to the upper frame.
- Attach a spool of **Filament** to the holders. Make sure the filament spool doesn't jam and can move freely.
- Plug in the AC power cord and turn on the switch.
- Check out the firmware version (in the Support menu via LCD panel) and please upgrade to the latest one from our website www.prusa3d.com/drivers.



Filament is a common term for the **plastic rod** - material provided on a spool from which 3D objects are printed.

6.3.1 Calibration flow and wizard

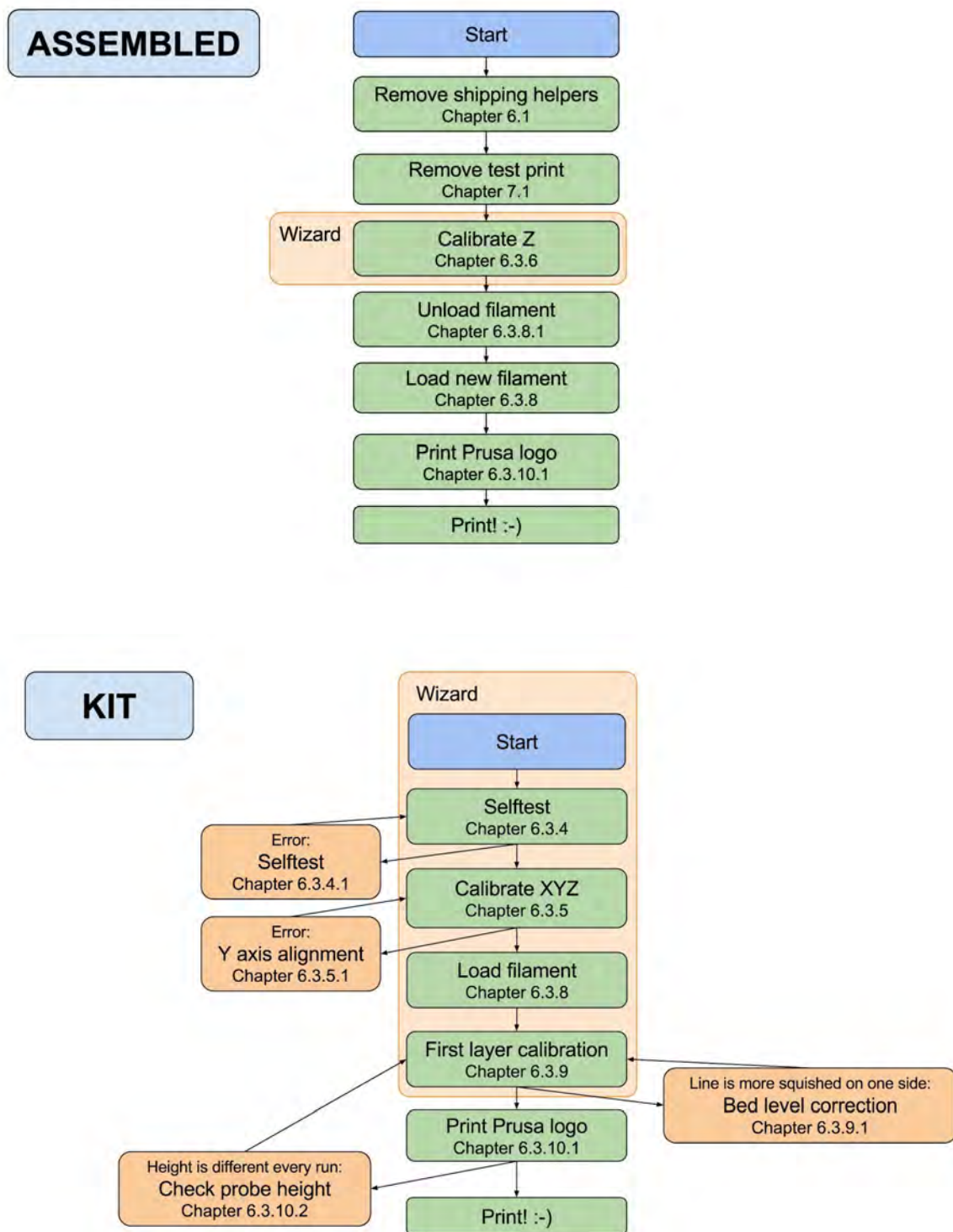

With the first start-up of your freshly-assembled printer, it will guide you through all the tests and calibrations you need to do to get started printing.

The Wizard can be also started manually from **LCD menu - Calibration - Wizard**. Do not forget to read chapter [6.3.2 Preparation of the spring steel sheet](#) before running the Wizard.

It follows the calibration flow and helps you with the following steps:

- **Selftest** - [Chapter 6.3.4](#)
- **Calibrate XYZ** - [Chapter 6.3.5](#)
- **Loading the filament** - [Chapter 6.3.8](#)
- **First layer calibration** - [Chapter 6.3.9](#)

It is not mandatory to use it, and you can cancel the Wizard at the beginning. Then you should just follow the calibration flow manually.

```
First, I will run
the selftest to
check most common
assembly problems. ✓
```

Pict. 4 - Wizard setup

There are a few special occasions where you will need to redo the calibration or a part of it.

- **Firmware update** - A complete guide is in chapter [13.9 Updating printer firmware](#).
- **Readjusting the SuperPINDA probe** - Run [6.3.6 Calibrate Z](#) to store new reference Z height values.



It is important to disconnect the printer USB from any computer or OctoPrint running on Raspberry Pi for the whole calibration because, during the calibration, the printer will not respond to any request from a host connected via USB, and communication will time out. Such a time out would cause the host to reset the connection, causing the printer to restart (in the middle of calibration) and it might end up in a weird state requiring [7.2.6 Factory Reset](#).

6.3.2 Preparation of the spring steel sheet

The MK52 heatbed has embedded high curie temperature magnets. These magnets are able to firmly hold removable spring steel sheets. There are two pins at the end of the heatbed that will align perfectly with cut out slots in the spring steel sheets. Make sure the bed is clean and there isn't any debris on it **before you put on the steel sheet. Never print directly on the heatbed.**

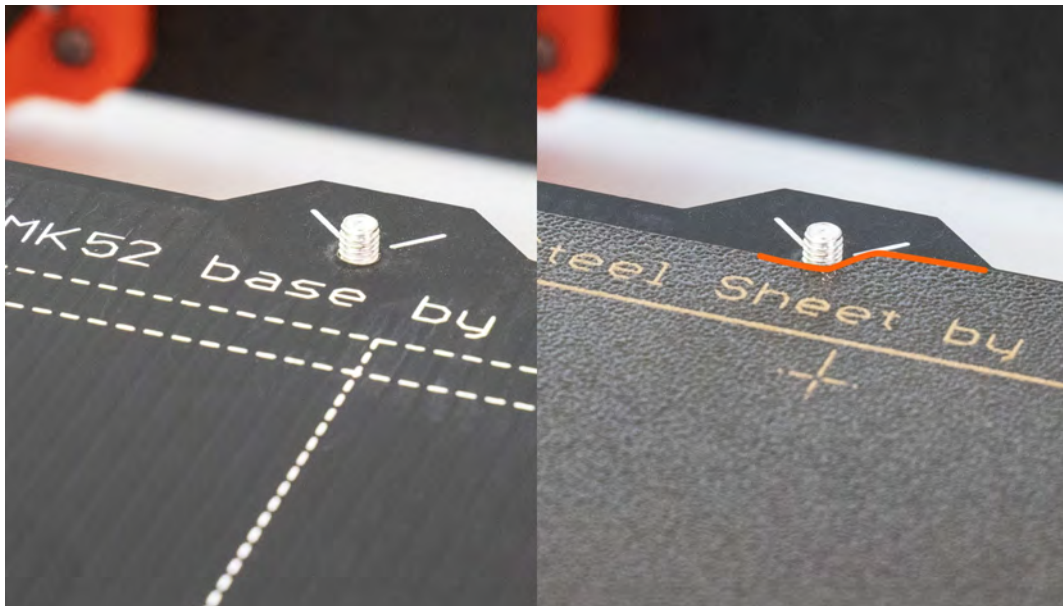

Pict. 5 - HeatBed MK52 base and powder coated steel sheet surface

To achieve the best adhesion on the new surface, it is important to keep the surface clean. Cleaning the surface is very easy. The best option is **Isopropyl alcohol** available in drugstores which is the best for ABS, PLA, and others. Pour a little amount on an unscented paper towel and wipe the print surface. The bed should be cleaned while cold for the best results but it can also be cleaned when already preheated for PLA, just be careful not to touch the bed surface or the nozzle. When cleaning at higher temperatures, the alcohol will evaporate before it can clean anything. Alternatively, you can clean the bed with **warm water and a few drops of dish soap** on a paper towel. **Denatured alcohol** is yet another option.



Consumable parts, such as PEI sheets (smooth, textured, satin, etc.) are not covered by warranty as the coatings will deteriorate over time unless failure has occurred due to a defect in materials or workmanship. Cosmetic damage, including but not limited to scratches, dents, cracks or other cosmetic damage is also not covered by the warranty. Only defective sheets on arrival are covered by warranty.



Calibration might be slightly different for different steel print sheets as the coating thickness varies. It is a good practice to check the first layer and adjust accordingly with **Live adjust Z** when switching between different types of steel sheets.



The surface does not have to be cleaned before every print! It is just important to **not touch** the steel sheet with **your hands** or **dirty tools**. **Clean your tools with the same solution** as you would the sheet and you will be able to start your next print right away.

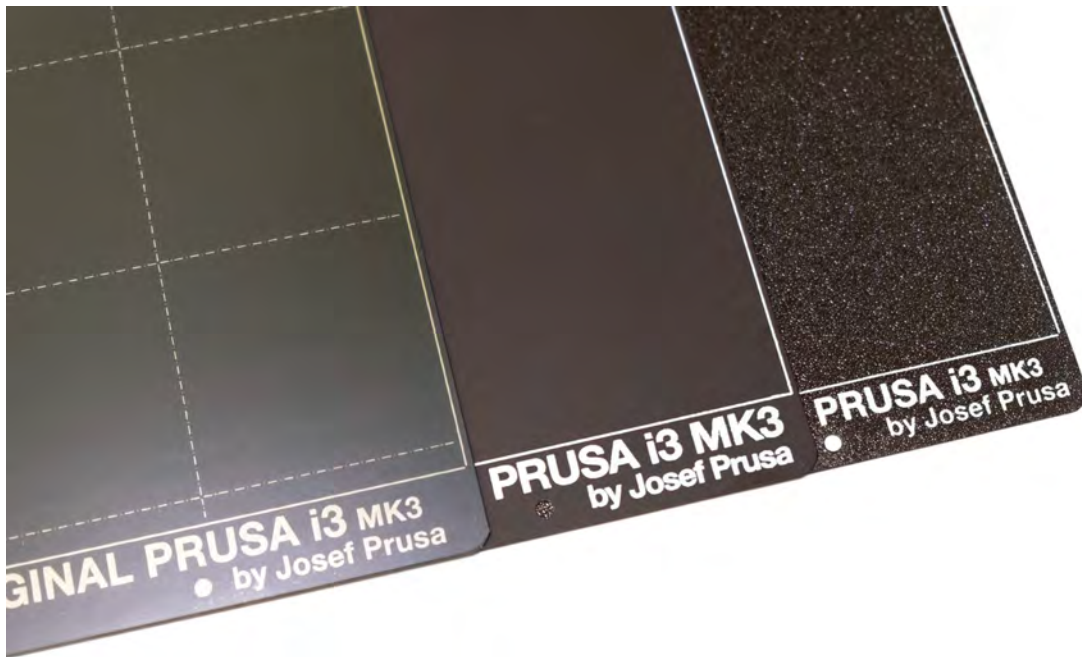

Pict. 6 - Steel print sheets - smooth, satin and textured powder-coated PEI sheet

i All original print surfaces by Prusa Research are coated from both sides.



Pict. 7 - Smooth PEI sheet (left), Satin powder coated sheet (middle), textured powder coated PEI sheet (right) effect on the first layer

i Due to a different thickness of the sheets, each sheet requires individual First layer calibration. To avoid re-calibrating every time you switch the sheet, you can save the settings for up to 8 sheets. Read more about this feature in chapter [8.1 Steel sheet profiles](#)

6.3.2.1 Double-sided textured PEI powder-coated spring steel sheet

- ✔ Scratchproof, hard to damage
 - ✔ Transfers texture to prints
 - ✔ More forgiving Live Adjust Z setting
 - ✔ No need for glue stick with FLEX
 - ✔ Prints automatically detach after sheet cools down
 - ✔ First layer can be more squished compared to smooth sheets
- ⚠ PLA prints with a small contact area may need a brim
 - ⚠ PLA prints with a huge footprint (one side 18cm+) may warp
 - ⚠ Live Adjust Z value needs to be changed if you switch sheets

Powder coating directly on metal makes it very hard to damage this build plate. If a heated nozzle crashes into it, the metal can dissipate the heat. Powder coating also gives the surface a distinct textured look that will be visible on your prints.









The textured surface hides most of the mechanical damage caused by tools. Only the top of the small bumps can be scratched, which will not imprint on the bottom of the model.



Never clean the textured powder coated sheet with acetone! Doing so will create microfractures in the PEI texture, which will make the surface deteriorate over time.

This surface is used on our print farm, look at the printed parts you have on your printer for reference.

6.3.2.2 Spring steel sheet with smooth double-sided PEI

-  Perfect for PLA
-  Great adhesion with almost all materials
-  Smooth bottom of prints
-  Tiny details will stick great
-  Rejuvenate with acetone from time to time
-  Do not clean with IPA before PETG
Release agent might be necessary
-  You must apply glue stick when printing Flex
-  Live Adjust Z value needs to be changed if you switch sheets

You can leave small marks on the print surface with your nozzle or tools, they will typically be shinier than the rest. It does not affect functionality or adhesion. However, if you want to have the same surface look on the whole printbed, you can rejuvenate it. The easiest way is to take the hard side of a dry kitchen sponge and gently wipe the affected area with a circular motion a few times.



The industrial glue which holds the PEI sheet on the heatbed itself softens when temperatures greater than 110 °C are used. If higher temperatures are used, the glue can migrate under the PEI and create slight bumps on the surface. To remove the bubbles, flip the sheet and print on the other side - they should disappear after a couple of prints.

6.3.2.3 Double-sided Powder-coated Satin Spring Steel Sheet

-  Suitable for both PLA and PETG
-  Lightly textured matte finish
-  No need for glue stick with FlexFill98A
-  Prints automatically detach after sheet cools down
-  Prints from ASA, PC Blend require a brim / skirt / shield around the print
-  Live Adjust Z value needs to be changed if you switch sheets
-  **Never clean with acetone**

The Satin powder coated sheet sits between the smooth and textured variants. Its powder-coated surface with lightly textured matte finish offers an optimal level of adhesion, especially when printing PLA and PETG materials. It is fully compatible with a wide range of common and less-common filaments, such as ABS, ASA, FlexFill 98A, Polycarbonate and more. A vast majority of materials can be printed without a separation layer (e.g. glue). Polycarbonate - prints better on satin (compared to smooth and textured sheets) - when printing with PC often, glue stick layer is recommended to prevent possible damage to the sheet.



Never clean the satin powder coated sheet with acetone! Doing so will create microfractures in the PEI coating and cause the surface to deteriorate.

6.3.2.4 Aftermarket sheets

The MK3S+ is a fully open source, so we expect other manufacturers to manufacture compatible aftermarket sheets. Look for references online before buying them, or check with our online support.



Sheets must be coated from both sides! If only one side is coated, the metal edge on the bottom side can damage the heated bed surface when the protective lacquer is scratched off.

6.3.3 Increasing the adhesion

On some special occasions, such as printing a tall object with a very small contact area (with the print surface), you might need to increase the adhesion. Fortunately, PEI is a very chemically resistant polymer and you can temporarily apply various adhesion solutions without damaging it. This also applies to materials that would not stick to PEI otherwise, like Nylon, etc.

Before applying anything onto the bed, consider using the **Brim option** in PrusaSlicer which increases the surface area of the first layer.

For Nylon blends, a simple glue stick does the trick. The glue can be easily removed later either using a window cleaner or dish soap water.

For ABS prints, ABS juice can be used and later cleaned with pure acetone. Be very gentle when applying the juice and do so while the bed is cold. Prints will attach very strongly. **Do not use ABS juice on the powder-coated spring steel sheet!**



Prepared juice can also be purchased in our e-shop. Unfortunately, carriers do not allow us to deliver any acetone-based products due to shipping constraints. In that case, you get only the bottle and ABS from our e-shop and you have to source the acetone locally.

6.3.4 Selftest (kit only)

The purpose of the selftest routine is to check the most common errors when assembling and connecting electronics and to help indicate any possible errors after the assembly. You can run the **Selftest** from the Calibration menu on the LCD panel. This should not be necessary on the assembled printers as those are pretested.

This routine consists of a series of tests. The progress and results of each step are displayed on the LCD. In case errors are found, the selftest is interrupted and the reason for the error is shown to guide users in troubleshooting.



The selftest is just a diagnostic tool, the printer will still attempt to print even after the test fails. If you are absolutely certain that the affected part is correct, you may continue with the print process.

The test consists of

- **Extruder and print fan** test
- **Heatbed** and **hotend** proper wiring
- **XYZ motors** proper wiring and functionality
- **XY axis** length
- **XY belts** tension
- **Loose belt pulley** test
- **Filament sensor** test

6.3.4.1 Selftest error messages and resolution (kit only)

Front print fan/ Left hotend fan - Not spinning:

Check proper wiring of the print and the hotend fan cables. Ensure that both are properly connected to the EINSY electronics and that they are not swapped.

Please check/ Not connected - Heater/ Thermistor:

Check the proper wiring of the hotend power cables and the thermistor cables. Ensure that both are properly connected to the EINSY electronics and that they are not swapped.

Bed/Heater - Wiring error:

Check that the heatbed and the hotend power cables are not swapped or that the thermistor cables from both the hotend and the heatbed are not swapped in the EINSY electronics.

Loose pulley - Pulley {XY}:

The belt pulley is loose and slips on the motor shaft. It is important to tighten the first grub screw on the flat piece of the shaft, then continue with the second grub screw.

Axis length - {XY}:

The printer measures the length of the axis by moving the print head from end to end twice. If the measured value is different from the physical length, your print head might be blocked from moving all the way. Check by hand if the print head moves smoothly when the printer is powered off.

Endstops - Wiring error - Z:

Check the proper cabling of the SuperPINDA probe. Routine indicates the SuperPINDA probe has a malfunction or is not properly responding. Check for the proper connection in the EINSY electronics.

Endstop not hit - Motor Z:

Check if the print head can be moved all the way down the Z-axis to trigger the SuperPINDA probe over the bed.

Please check: Filament sensor - Wiring error:

Check the wiring of the filament sensor cable for any damage. Ensure that one end is connected to the filament sensor and the other one to the correct slot on the EINSY board.

6.3.5 Calibrate XYZ (kit only)



The Original Prusa i3 MK3S+ comes with a full mesh bed leveling feature, however, for this to work, we need to first calibrate the distance between the tip of the nozzle and the SuperPINDA (**Prusa INDuction Autoleveling**) probe.

The process is fairly straightforward; so let's get to it.

The purpose of the X/Y/Z calibration routine is to measure the skew of the X/Y/Z axes and to find the position of the 4 calibration points on the print bed for proper bed leveling. You can run the **XYZ calibration** from the **Calibration** menu on the LCD panel. This should not be necessary on the assembled printers as those are factory calibrated.

Place a sheet of a regular office paper (for example, the checklist shipped with every order) and hold it under the nozzle during the first round (first 4 points being checked) of calibration. If the nozzle catches on the paper during the process, power off the printer and lower the SuperPINDA probe slightly. See more info in [6.3.10.2 Check probe height](#). The paper will not affect the calibration process. The nozzle must not touch the print surface or deflect the bed by any means. If everything went correctly, continue with the calibration process.

Initiating this routine performs a series of measurements in three rounds: In the first round, **without the steel sheet installed**, 4 sensor points on the print bed are searched for carefully, so as not to touch the print bed with the nozzle. In the second round, the point locations are being improved. In the last round, **with the steel sheet on**, the height above the 9 sensor points is measured and stored in non-volatile memory for reference. This finishes the Z-axis calibration.

At the start of the XYZ calibration procedure the printer homes the X and Y-axis. After that, the Z-axis will begin to move up until both sides touch the printed parts at the top.

Please make sure the print head went all the way up the Z-axis and that you heard a rattling sound as the Z stepper motors skip steps. This procedure ensures, that 1) the X-axis is perfectly horizontal, 2) the print nozzle is in a known distance from the print bed. If the print head did **not** touch the end stoppers at the top of the Z-axis, the printer could not possibly know the distance the print nozzle is from the print bed and it could, therefore, crash into the print bed during the first round of the X/Y calibration procedure.

The printer also checks the temperature of the SuperPINDA probe.

The XYZ calibration procedure also prompts you to ***"Please clean the nozzle for calibration. Click when done."***

If this advice is not followed and there is plastic debris on the print nozzle, then the debris may touch the print bed or even push the print bed away from the SuperPINDA probe, so the SuperPINDA probe will not trigger properly and the calibration will fail.

You can check the status of the SuperPINDA probe in **LCD Menu - Support - Sensor info**.

After the calibration is passed, the values can be reviewed for tweaking later. If you have the axes **perpendicular** or **slightly skewed**, nothing needs to be tweaked because the printer will perform with the best accuracy. Learn more in chapter [8.5 View XYZ calibration details \(Optional\)](#) under [8 Advanced calibration](#).

6.3.5.1 Calibrate XYZ error messages and resolution (kit only)

1) **XYZ calibration failed. Bed calibration point was not found.**

The calibration routine did not find a bed sensor point. The printer stops close to the bed point, which it failed to detect. Please verify that the printer is assembled correctly, that all axes move freely, the pulleys do not slip, and the print nozzle is clean. If everything looks good, re-run the X/Y calibration and verify, with a sheet of paper between the nozzle and the print bed, that the print nozzle does not touch the print bed during the calibration routine. If you feel friction of the nozzle against the sheet of paper and the nozzle is clean, you need to screw the SuperPINDA probe slightly lower and re-run the X/Y calibration.

2) **XYZ calibration failed. Please consult the manual.**

The calibration points were found in positions far from what should be expected from a properly assembled printer. Please follow the instructions of case 1).

3) **XYZ calibration ok. X/Y axes are perpendicular. Congratulations!**

Congratulations, you built your printer precisely; your X/Y axes are perpendicular.

4) **XYZ calibration all right. X/Y axes are slightly skewed. Good job!**

Good job, the X/Y axes are not precisely perpendicular, but still quite all right. The firmware will correct for the X/Y skew during normal printing, so boxes will be printed with right angles.

5) **XYZ calibration all right. A skew will be corrected automatically.**

The firmware will correct the skew during normal printing and as long as the X and Y axes move freely, the printer will print correctly. You may want to consider revisiting the assembly guide and try to re-align the X/Y axes.

During the mesh bed leveling procedure, the following errors may be reported on the display.

1) **Bed leveling failed. Sensor disconnected or cable broken. Waiting for reset.**

Verify, whether the SuperPINDA probe cable is plugged into the EINSY RAMBo board correctly. If that is the case, the SuperPINDA probe is broken, and it needs to be replaced.

2) **Bed leveling failed. Sensor didn't trigger. Debris on nozzle? Waiting for reset.**

This is a safety check to avoid crashing the nozzle into the print bed if the SuperPINDA sensor stops working or something goes wrong with the printer mechanics (for example, a pulley slips). This safety check may also be triggered if the printer has been moved to an uneven surface. Before doing anything else, make the Z-axis level by going all the way up and try again.

At the end of the X/Y calibration, the printer measures the reference height above each of the 9 bed sensor points and stores the reference heights in non-volatile

memory. During normal bed leveling, it is expected that the SuperPINDA probe triggers no more than 1 mm from the reference value, therefore the nozzle is not allowed to move more than 1 mm below the reference value during the bed calibration.

If you moved the printer, you may need to re-run the Z calibration to sample new reference Z height values reflecting the twist and bend of the table surface the printer is sitting on. If that does not help, please verify, that the SuperPINDA probe is aligned with the sensor points on the print bed during the bed Z calibration. The alignment shall be ensured by the automatic X/Y calibration routine. If the SuperPINDA probe is not aligned during the Z calibration over time, it is possible, that a pulley is slipping or something on the machine's frame got loose.

3) ***Bed leveling failed. Sensor triggered too high. Waiting for reset.***

Similar to case 2). This time the SuperPINDA sensor triggered more than 1 mm above the reference height. Before doing anything else, make the Z-axis level by going all the way up and try again.

6.3.6 Calibrate Z

Calibrate Z is located in the **LCD Menu - Calibration - Calibrate Z**. It is always done with **the steel sheet on**. It should be performed whenever you move the printer to a different location. It saves the heights of all 9 calibration points in non-volatile memory. The stored information is used every time mesh bed leveling is called during a print. When the measured values are vastly different from the stored values, the print is canceled because it is a good indicator something is wrong. Calibrate Z is a part of the routine Calibrate XYZ so there's no need to run it after a successful Calibrate XYZ.

It is a good practice to run this procedure every time you travel with the printer or the printer is shipped the geometry might change slightly and cause an error.

At the start of the Z calibration procedure the printer homes X and Y-axis. After that, Z-axis will begin to move up until both sides touch the printed parts at the top.

Please make sure the Z-axis went all the way up and you heard a rattling sound as the Z stepper motors skip steps. This procedure ensures that 1) the X-axis is perfectly horizontal, 2) the print nozzle is in a known distance from the print bed. In case the Z carriage did **not** touch the end stoppers, the printer could not possibly know the height of the print nozzle above the print bed and the Z calibration procedure will fail.

The Z calibration procedure also prompts you to ***"Please clean the nozzle for calibration. Click when done."***

If this advice is not followed and there is plastic debris on the print nozzle, then the debris may touch the print bed or even push the print bed away from the SuperPINDA probe, so the SuperPINDA probe will not trigger properly and the calibration will fail.

6.3.7 Mesh bed leveling

Mesh bed leveling can be found in **LCD Menu - Calibration**. This procedure is performed before every print. It is also the same procedure that happens in the second round of XYZ calibration.

The SuperPINDA probe goes through a number of points in a grid pattern spread across the sheet plate (whether it is a powder coated or smooth PEI does not matter) and measures the distance to the sheet. These points are interpolated and used to create a virtual mesh of the bed. During printing, if the bed is slightly warped, the probe will still precisely follow the surface according to its measured mesh.

Mesh bed leveling settings

The default grid density is **3x3 (9 points)**. However, if you still experience an uneven first layer adhesion, you can increase the density in **Settings - Mesh bed leveling - Mesh** to **7x7**. Additionally, changing the **Z-probe nr.** you can change how many times will each point be probed. We suggest either 3 or 5 measurements since the final value is calculated as an average value. Changing these settings affects how long will the Mesh bed leveling procedure takes to complete. However, even the slowest variant finishes in under a minute.

Finally, with 7x7 Mesh bed leveling, you can choose whether or not to use **Magnets compensation**. The removable flexible sheet dampens the magnetic field significantly. Still, 11 of the 49 points are so close to magnets, that the reading can be off by as much as 80µm. Magnet compensation ignores readings from these 11 points and calculates them from the surrounding points. We suggest leaving this function **on**.

The StallGuard for the Z-axis is active during the mesh bed leveling. In case the nozzle crashes into the bed before the SuperPINDA probe triggers, the calibration process is interrupted and the user is asked to check the nozzle for any kind of debris.

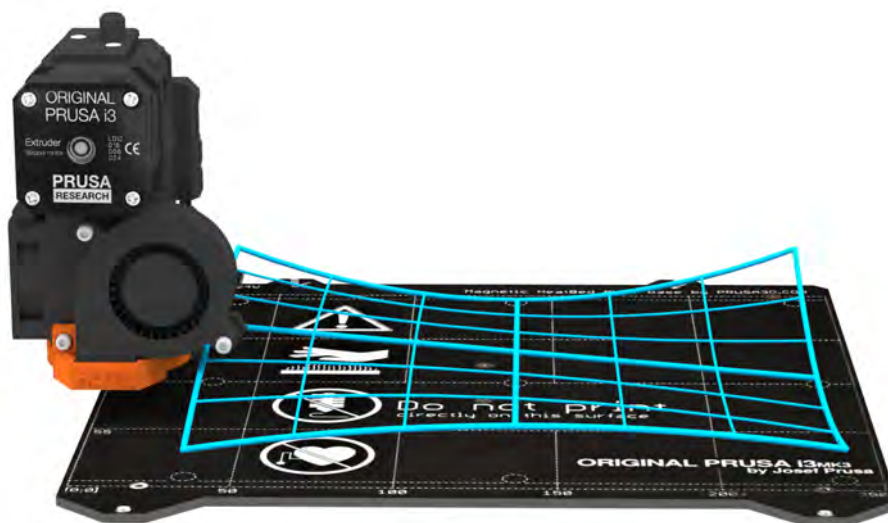

Pict. 8 - Visualisation of mesh bed leveling

6.3.8 Loading the filament into the extruder

Before you can load the filament, the printer must be preheated for the correct filament type.

If you have the filament sensor or autoloading disabled in the settings, you can manually start the loading process from the LCD menu.

1. Press the control knob on the LCD panel to enter the main menu.
2. Insert the filament into the extruder.
3. Choose the **Load filament** option in the menu and press the button to confirm.
 - a. If the nozzle is not preheated, the preheat menu will be automatically shown. So select the filament type and confirm by pressing the control knob.
 - b. Wait for the nozzle to reach the target preheat temperature.
 - c. Insert the filament into the extruder and confirm loading by pressing the control knob.
4. The filament is then loaded to the extruder by the extruder stepper automatically.

If you have **the filament sensor and autoloading enabled**, preheat the printer and simply insert the filament into the extruder. Everything is automated from this point. Make sure that the filament tip is nice and pointy. The Z-axis will rise in case the current Z coordinate is less than 20mm from the print bed. This will ensure that there is always enough space for cleaning the nozzle.

You should cut the top of the filament as shown in the next picture.



Pict. 9 - Loading the filament into the extruder

If your filament is running out during a print, you can easily replace it with a new spool. Just go to the LCD menu, select the Tune submenu and press **Change filament**. The printer will

pause, the print head will go out of the print area, unload the old filament, and the LCD will guide you on what to do. You can even insert filament of a different color and make your prints more colorful. Check out chapter [11.3 Printing in color with ColorPrint](#) to find out how to make more intricate color models.



Read the chapter about our new [13.3 Filament sensor](#) and its functions.

6.3.8.1 Unloading the filament

This procedure is similar to the loading operation. Select **Unload filament** option from the menu. If the nozzle is not preheated, the preheat menu will be automatically shown. Select the filament type and confirm your selection by pressing the control knob. After the printer reaches the target temperature, press the knob to unload the filament. If the nozzle was preheated, the filament is unloaded immediately.

6.3.9 First layer calibration (kit only)

Now we will finally calibrate the distance between the tip of the nozzle and the probe.



Check if your print surface is clean! You can find instructions on how to clean it in the chapter [6.3.2 Preparation of the spring steel sheet](#). Don't forget to complete [6.3.5 Calibrate XYZ](#) chapter or **you can permanently damage the print surface!**

You can launch the calibration from **LCD Menu - Calibration - First layer cal.**

The printer will probe the bed and start printing a zig-zag pattern on the print surface. The nozzle will be at the height based on the SuperPINDA probe setting, it must not by any means touch the printing surface. If you have already calibrated the first layer and you run the process again, the printer will ask you whether you want to use the old Live Z value.



Pict. 10 - How to tune the nozzle height live during the test print. Note: -0.640 mm is only for illustration. Your setting will be different!

Observe the line which is being extruded on the print surface. A new menu will automatically show up where you can tune the nozzle height in real time by turning the knob. The aim is to adjust the nozzle height until the extruded plastic sticks nicely to the bed and you can see that it is being slightly squished. The value should not exceed -2.000 mm. **If you have to adjust it more (e.g. -2.500), move the SuperPINDA probe slightly higher. Please refer to help.prusa3d.com in case the SuperPINDA probe needs to be re-aligned.**

Loosen the M3 screw on the probe holder to make adjustments. Gently push or pull the sensor to adjust the height and tighten the M3 screw again. Then re-run Calibrate Z followed by the First layer calibration again.

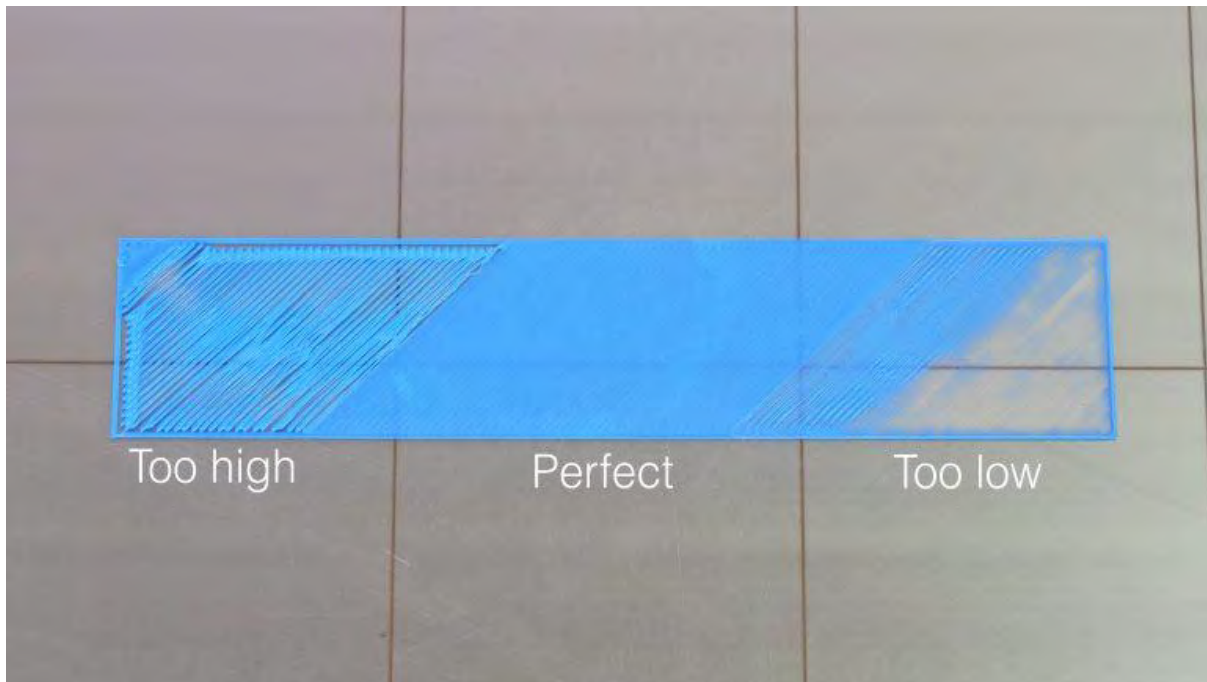

Pict. 11 - The properly-tuned first layer



When printing the extruder motor can reach up to 55°C, that is completely fine, they are designed to run up to 100 °C.

6.3.9.1 Bed level correction (kit only)

Bed level correction is an advanced feature that is designed to allow advanced users to correct for the slightest imperfections in the first layer. This feature can be found in **LCD Menu - Calibration - Bed level correction**. For example, if the first layer seems to be ever so slightly more squished on the right side, you can virtually raise the nozzle by **+20** microns on the right side. Settings are available for Left, Right, Front and Back. The limit is +-100 microns and even +-20 microns can make a huge difference. When you are using this function, perform small incremental changes. A negative value will cause the bed to lower in the selected direction.

6.3.10 Fine tuning the first layer

6.3.10.1 Print Prusa logo

After finishing the calibration g-code, it is a good idea to print a simple object. The Prusa logo from the supplied SD card is a great example. The **Live adjust Z** function (described in [6.3.9. First layer calibration](#)) works during every print, so you can fine tune at any point. You can see the properly-tuned first layer in Pict. 12.



Calibration might be slightly different for different steel print sheets as the coating thickness varies. It is a good practice to check the first layer and adjust accordingly with **Live adjust Z** when switching between different types of steel sheets. You can find more info and photos at help.prusa3d.com.

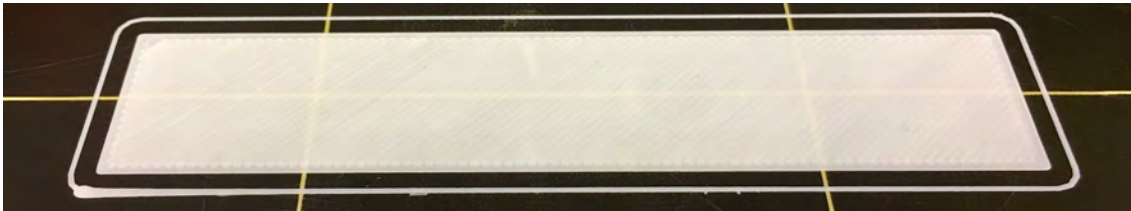

Pict. 12 - Perfect Prusa logo first layer

6.3.10.2 Check probe height (kit only)



If the first layer seems inconsistent between multiple prints, the probe might be too high. Lower it slightly. Loosen the M3 screw on the probe holder and gently push the sensor to adjust the height and tighten the M3 screw again. Then try again **Calibrate XYZ**. Keep in mind, the probe must always be higher than the nozzle tip, otherwise, it will catch on prints.

Now you are done!

7 Printing

Make sure that the nozzle and the bed are heated to the desired temperature. If you forget to preheat the printing nozzle and the bed before printing, the printer will automatically check the temperatures of the nozzle and the bed; printing will start when the desired temperature is reached - that can take several minutes. However, we recommend preheating the printer beforehand as described in chapter [6.3.8 Loading the filament into the extruder](#).



Do not let the preheated printer idle. When a printer is preheated and non-printing, material in an extruder degrades over time - it may cause the nozzle to jam up.

- **Watch the first few printed layers to be sure filament has attached to the bed properly (5 to 10 minutes).**
- Press the LCD-knob and choose the **Print from SD** option from the menu, press to confirm and pick the desired model **file_name.gcode**. The printer will start printing the object.



The **filename (.gcode) must not contain any special characters** otherwise the printer is not able to display the file on the LCD.

7.1 Removing objects from the printer

Removing prints from the build plate is much easier because of the ability to remove and bend the build plate. Different thermal expansion of the steel sheet and plastics used in 3D printing also helps with detaching prints after the plate has cooled down.

- When the printing is finished, let both nozzle and heatbed cool down before removing the printed object. Always handle the printed objects when the temperature of the bed and nozzle drop to room temperature. When the bed is hot, objects are very hard to remove. Remove the steel sheet from the printer and bend it slightly; prints should pop off.
- If you experience any troubles removing the object (especially the small ones), you can use a flat tool like a spatula **with rounded corners** to prevent damage to the PEI. Slide the spatula under the corner of the object and gently push until the print pops off.



Pict. 13 - Removing the model from the PEI print surface by bending the steel sheet.

i If the prints still do not want to get loose or you need to bend the sheet too much (which you should not do), try to bend the sheet **inwards**.

7.2 Printer Control

There are two ways to control the printer. You can use the LCD panel integrated with the printer, or you can connect your computer via the USB cable. We suggest the **LCD panel** because of its speed and reliability, and moreover you do not have to rely on a computer.

7.2.1 LCD screen

The main screen is an **information screen** displaying the most important details. They are the temperature of the nozzle and the heatbed (1, 2), printing time (3) and the actual Z-axis position (5).

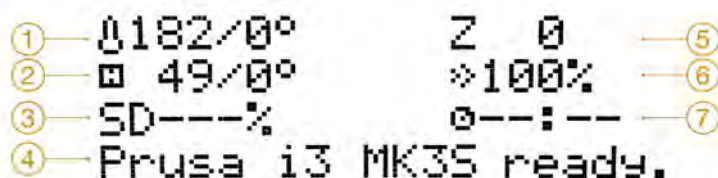

Pict. 14 - LCD layout

1. Nozzle temperature (actual / desired temperature)
2. Heatbed temperature (actual / desired temperature)
3. Progress of printing in % - shown only during the printing
4. Status bar (Prusa i3 MK3S+ ready. / Heating / file_name.gcode, etc.)
5. Z-axis position
6. Printing speed
7. Remaining time estimation

7.2.2 Controlling the LCD screen

Controlling the LCD screen is done by a single control element: a rotational knob that you press to confirm the selection.



Pict. 15 - LCD screen and control buttons

By single pressing the control button on the information screen, you enter the main menu.

The reset button is placed directly under the control knob. Pressing the reset button equates to quickly toggling the power switch. It is useful when the printer exhibits weird behavior or you see a failed print that requires immediate cancellation.

During some LCD functions like Calibration Wizard, you may encounter special symbols in the bottom right corner.

∨ ∨ Double down arrow informs you that the message contains more screens that automatically switch and you should wait.

⚡ Tick sign informs you that you need to press the control knob to continue.

 **Shortcut:** Quick access to Move Z-axis function - press and hold the Control knob for 3 seconds

7.2.3 Print statistics

The printer tracks printing statistics. When you access this option during a print, you will see statistics for the running print. If you do so while the printer is idle, you will see the lifetime statistics. Both filament usage and print time are tracked.

```
Total filament :  
                    5.94 m  
Total print time :  
    0d : 1h :58 m
```

Pict. 16 - Print statistics

7.2.4 Fail stats

The printer keeps statistics about the failures it experienced and recovered from during the last print. It is useful for assessing a long print, for example over a night or a weekend, if everything ran smoothly. Fail stats are placed at the bottom of the LCD menu.

Failures which are detected:

- Filament runout
- Power panic
- Lost steps / shifted layers

7.2.5 Normal vs. Stealth mode

The printer offers two print modes. **Normal mode** is required for the detection of lost steps (shifted layers) while still being quieter than silent mode on MK2/S. The second is called **Stealth mode** and utilizes Trinamic StealthChop technology, making the printer almost inaudible with the print cooling fan being the noisiest part of the printer. However, **Stealth mode** does not provide lost step detection. Furthermore, printing in **Stealth mode** is about **5-20% slower** (depends on the particular model) than printing in the Normal mode.

These modes can be changed in two ways:

1. In **LCD Menu - Settings - [Normal/ Stealth]**
2. During prints **LCD Menu - Tune - [Normal/ Stealth]**

7.2.6 Factory reset

The factory reset is used when troubleshooting the printer and resetting it to the factory state.

Entering the factory reset menu:

1. **Press and release the reset button** (marked X and positioned under the control knob on the LCD panel)
2. **Press and hold the control knob** until you hear a beep
3. **Release the control knob**

Options:

- **Language** option resets the language preference.
- **Statistics** will erase all the recorded print time and material from the memory.
- **Shipping prep** which resets only the printer language selection. All the calibration data including the Live adjust Z remain intact. Even though the calibration data are still present and functional, the printer will prompt the user once to run the Calibrate Z function. This “light” factory reset is mainly used for resetting of assembled printers before shipping out of the factory so that users can select their language and run Calibrate Z after unpacking.
- **Service prep** which is used by Prusa technicians before a repaired printer is sent back to the customer
- **All data** which resets everything including all calibration data and the whole EEPROM is cleaned. After this reset, the user is expected to go through the calibration flow again, except setting the probe height.

If you experience random glitches after a firmware update, or after a printer upgrade, use the **All data** option.

7.2.9 LCD layout

Items not mentioned below are not used for the common print setup - you should not change any of the unmentioned items unless you are absolutely sure what you are doing.

- Info screen
- Live adjust Z (during the printing process only)
- Tune (during the printing process only)
 - Speed
 - Nozzle
 - Bed
 - Fan speed
 - Flow
 - Change filament
 - Mode
- Pause print (during the printing process only)
- Stop print (during the printing process only)
- Preheat
 - PLA - 215/60
 - PET - 230/85
 - ASA - 260/105
 - PC - 275/110
 - PVB - 215/75
 - ABS - 255/100
 - HIPS - 220/100
 - PP - 254/100
 - FLEX - 230/50
 - Cooldown
- Print from SD
- AutoLoad Filament (Load filament if Filament autoloader is off)
- Unload filament
- Settings
 - Temperature
 - Nozzle
 - Bed
 - Fan speed
 - Move axis
 - Move X
 - Move Y
 - Move Z
 - Extruder
 - Disable steppers
 - Filament sensor - On / Off
 - F. autoloader - On / Off / N/A
 - Fans check - On / Off
 - Mode - Normal / Stealth
 - Crash detection - On / Off
 - HW setup
 - Steel sheets
 - Nozzle d. - 0.25 / 0.40 / 0.60 / 0.80
 - Checks

- Nozzle - warn / strict / none
 - Model - warn / strict / none
 - Firmware - warn / strict / none
 - FS Action - Pause / Continue
 - Fsensor Detection
- Mesh bed leveling
 - Mesh 3x3 / 7x7
 - Z-probe nr. 1 / 3 / 5
 - Magnets comp. - On / Off
- Lin. correction
- Temperature calibration - On / Off
- RPi port - On / Off
- Live adjust Z
- Select language
 - Community made
- SD card - Normal / FlashAir
- Sort - Time / Alphabet / None
- Sound - Loud / Once / Silent / Assist
- Brightness
 - Level Bright - default 130 (50 - 255)
 - Level Dimmed - default 50 (0 - 130)
 - Mode - Auto / Bright / Dim
 - Timeout - default 10 (1 - 999)
- Calibration
 - Wizard
 - First layer calibration
 - Auto home
 - Belt test
 - Selftest
 - Calibrate XYZ
 - Calibrate Z
 - Mesh Bed Leveling
 - Bed level correction
 - PID Calibration
 - Reset XYZ calibration
 - Temperature Calibration (only on MK3S)
- Statistics
- Fail stats
 - Last print
 - Total
- Support
 - Firmware version
 - Fil. sensor v.
 - XYZ calibration detail
 - Extruder info
 - Sensor info
 - Belt status
 - Temperatures
 - Voltages
 - Dump Memory

7.2.10 Print speed versus print quality

Printing a small object takes a few minutes, but larger models are more time-consuming. There are prints that take dozens of hours to complete. The overall printing time can be changed using various methods. The first way is to change the layer height in PrusaSlicer using the **Print settings** option in the upper right corner. The default setting is **0.15 mm** (QUALITY). By choosing taller layer heights you can significantly shorten the print time (0.20 mm or 0.30 mm) at the cost of more visible layers. On the other hand, choosing **0.10 mm** (DETAIL) will result in extra detail at the cost of longer print times. **Generally, we do not suggest going lower than 0.10 mm** as the improvement in print quality with 0.07 or 0.05 mm layers is relatively minor with significantly longer print times.

Our most used profiles **0.15 mm** and **0.20 mm** come in two different versions.

- **Quality** - slower perimeters and infill, gives you better surface quality
- **Speed** - faster perimeters and infill without much sacrifice of surface quality



Pict. 19 - Print quality vs print time

The speed can also be changed while printing. The LCD shows the FR 100 % item - it's actual print speed (feed rate). By turning the LCD-knob clockwise you can increase the print speed up to 999 %. However, we do not advise increasing the speed over 200 %. Watch the results of increased speed on the printed model and adjust the speed accordingly.

 When increasing the speed always check that the model is cooled properly - especially when printing a small object from ABS, increased speed causes distortion (sometimes called “warping”) of the model. You can prevent this issue by printing more similar objects together - layer printing interval is long enough to prevent this issue.

If the model shows a lower quality than desired, you can decrease the printing speed - turn the LCD-knob counterclockwise. The minimum usable printing speed is around 20 % of the nominal speed.

7.2.11 USB cable and Pronterface

i We strongly recommend using the LCD panel / SD card while printing on the Original Prusa i3 MK3S+ - Pronterface doesn't support all functions of the new firmware (e.g. filament change while printing).

Keep in mind that when printing from Pronterface, the **computer must be connected to the printer during the whole printing process** - the computer must be prevented from sleep, hibernation, or shutting down. Disconnecting the computer during the print ends the printing without the option to finish the object.

- Connect the printer to the computer with the USB cable.

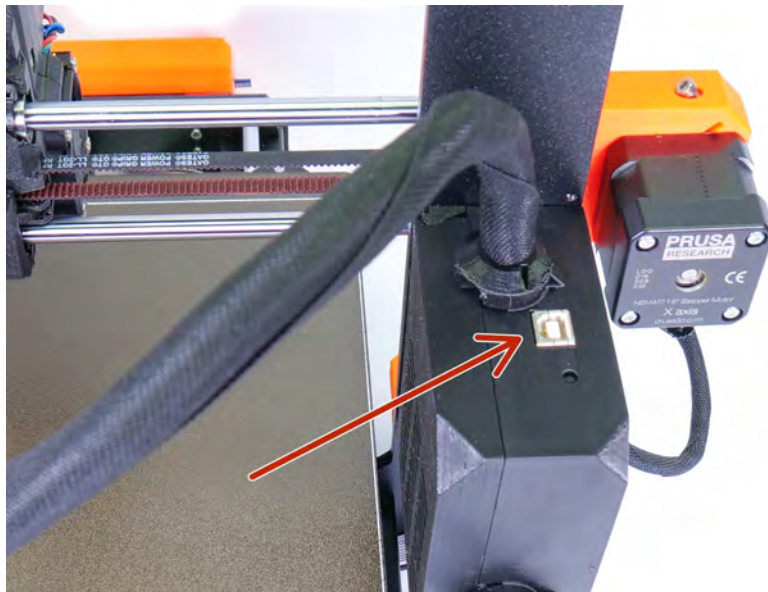

Pict. 20 - You can find the USB port here

- Choose the connection port in Pronterface (download available with the printer drivers; see the chapter [9 Printer drivers](#)): Mac users use `/usbmodem` port, PC Windows ports are COM1, COM2, etc.; the correct port is displayed in the device manager, Linux users connect the printer using the virtual serial port. When the printer is connected, click the **Connect** button. The right column displays the connection information.
- The next step is loading the model with **Load model** button and choosing the **file_name.gcode** (no special symbols in file name).
- You can control the movement of all printer axes using the control area.
- Next, you can preheat the printer and prepare it for printing. Set the temperatures for the nozzle (heater) and heatbed (bed) and click **Set** button. The printer starts heating

up immediately. **Always check that the temperatures set in Pronterface are correct according to our material guide!**

- You can check the actual temperatures of the nozzle and the bed in Pronterface.
- When the model is loaded, the right column shows the estimated print duration: **Estimated duration (pessimistic)**

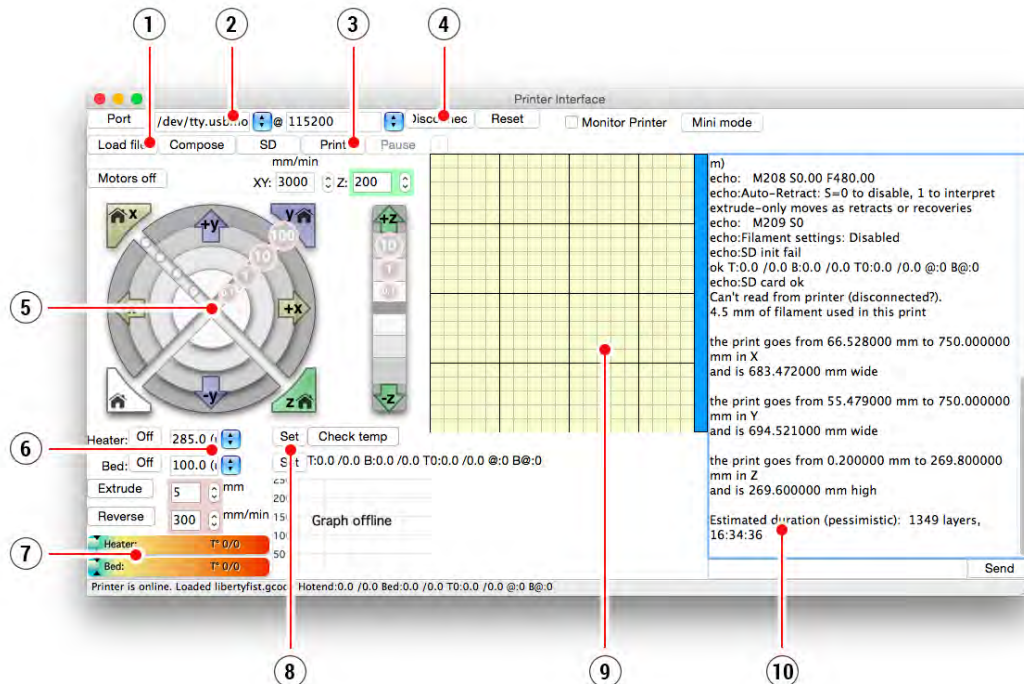

Pict. 21 - Pronterface

1. **Load file** button is used to load the desired model. The model must be in a ***.gcode** file format.
2. Choose the port by which the printer is connected to the computer (mostly */usbmodem* for Mac, COM1, COM2, etc for Windows PC).
3. The **Print** button starts the printing process.
4. The **Disconnect** button disconnects the printer from the computer.
5. Printer controls. Here you can manipulate the printer axes.
6. Setting the nozzle and bed temperatures.
7. **Thermometer**.
8. Confirming the set temperatures, heating starts.
9. 2D print process preview.
10. Info panel. Estimated print time, axis position and other info are displayed after loading the model.

7.2.12 Power panic

The printer can fully recover from a complete loss of power without the need for batteries. A special sensor detects mains voltage and in case of an interruption, it immediately shuts down the heatbed and extruder heating, leaving enough power in the capacitors to store the

position and lift the print head away from the print. In case of a very short power failure, the printer will attempt to continue printing immediately without waiting for user interaction. The printer can recover from consecutive power outages or even very short power outages (<50 ms).

When the power comes back, the printer will give you an option to continue the print. Keep in mind that during long periods without power, the bed will cool down and the print can detach itself from the sheet plate. Power panic doesn't work if you interrupt the print with the on/off power switch.

7.2.13 Crash detection

The Trinamic drivers on the EINSY board can detect skipped steps and layer shifting. It works only in the **normal mode (not in the Stealth mode)**. The thresholds for crash detection are set for higher speeds because layer shifting happens most of the time when the extruder moves fast between objects and hits a piece of curled up print. Make sure that your **belt and pulley are tightened**. Would any of them be loosened, it may cause the belt to jump over the pulley or the pulley to spin around the motor shaft and the printer will not be able to detect it. Check out chapter [14.4 Loose X- and/or Y-axis belts](#).

If you want to test crash detection, just pinch the smooth rods and let the extruder hit your hand. Crash detection doesn't work if you push the extruder in the direction of its movement. That's not a real-world scenario and normally never happens during print.

7.2.14 Temperatures

By default, the printer shows the heatbed and hotend temperatures on the LCD screen. If you also want to check the ambient temperature, you can do so in the **LCD Menu - Support - Temperatures menu**. The same menu is available during the print.

The printer uses the ambient temperature reading to differentiate between MINTEMP caused by low ambient temperature (below 10°C) and an actual problem with either the thermistor or the heating element.

7.2.15 Voltages

If you encounter really long preheat times, or the printer is behaving in a weird way, you can check the PSU output voltage in the **LCD Menu - Support - Voltages** menu. You should see the PWR (power supply) value of around 24V (+- 0.5V). If you see a drastically different value, check the connection between the PSU and EINSY board and contact our support if the problem persists. The BED (heatbed) voltage should be almost the same as PWR voltage. If you see value around 0V, check the 15A fuse on the bottom of the EINSY board. The IR value represents the actual voltage measured on the pin of the filament sensor. With the filament inserted in the extruder, the value will be between 0.3-0.5 V. Without filament, the value should be between 4.2-4.6 V.

7.2.16 Safety timer

This feature turns off the nozzle and bed heaters if the printer is idle for more than 30 minutes.

7.2.17 Beeper settings

There are 4 levels of acoustic signalization: **Loud**, **Once**, **Silent** and **Assist**. The user is able to choose between each level in the printer's **LCD Menu -> Settings -> Sound**. You can also change the sound settings during the print in the **LCD Menu -> Tune**.

Level description:

- **Loud** - printer uses acoustic signalization for failure or if confirmation is needed
- **Once** - this level is similar to Loud, but all beeps are played only once
- **Silent** - most of the beeps are muted, the user is informed only in case of a serious error
- **Assist** - accessibility feature which plays a different sound while scrolling through the menu and at the end of the menu

7.2.18 Language settings

The following languages are supported: English, Czech, German, Spanish, Italian, Polish and French. Go to the printer's **LCD Menu - Settings - Language** and select any of the available languages. In addition to the officially supported languages, you can also select any of the community made translations from the **LCD Menu - Settings - Language - Community made** submenu.

To flash firmware including the translations, you need to use PrusaSlicer's built-in firmware flasher. Please refer to chapter [13.9 Updating printer firmware](#).

7.2.19 Dump memory

The **LCD Menu - Support - Dump Memory** feature is a debugging support tool. It allows you to store the RAM content into the xFlash memory for further issue/bug analysis. If you report a bug to our GitHub repository, our developers might ask you to use this feature to better understand the cause of the problem.

7.3 Printer addons

7.3.1 Different nozzles



You have to use proper preset settings for different nozzles in PrusaSlicer.

Please, check out how to change the nozzle in section [13.6 Replacing / changing the nozzle](#).

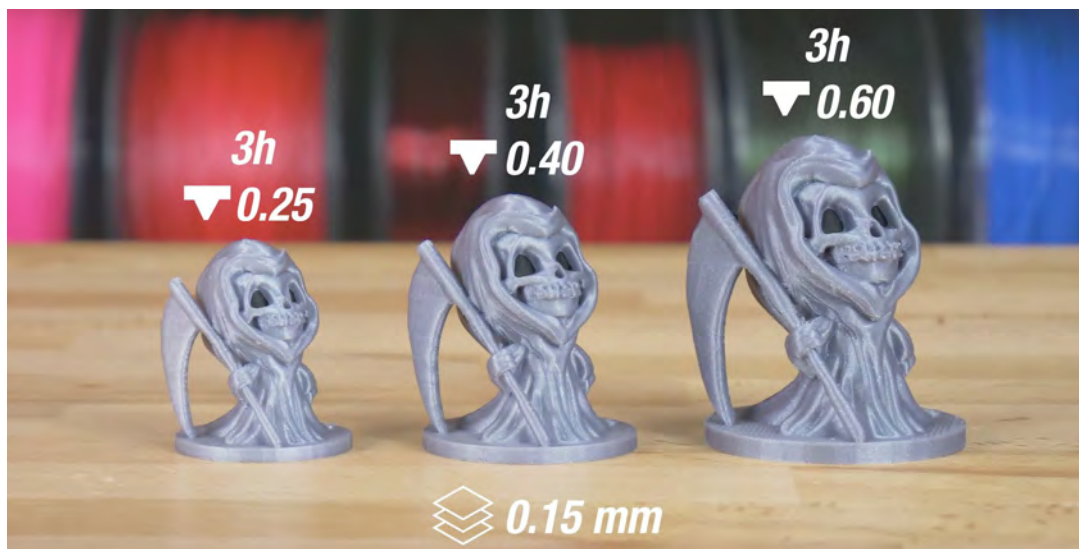

Pict. 22 - Different nozzle sizes have big impact on print speed

7.3.1.1 0.6 and 0.8 nozzles by E3D

E3D, a UK-based company, that supplies hotends for the Original Prusa i3 MK3S+, has a whole ecosystem of upgrades and addons. We support some of them including the 0.8, 0.6, 0.25 and the hardened steel nozzle.

The 0.8 and 0.6mm nozzles are suitable for any print that doesn't rely on tiny details. Headphone stands, various holders, racks or flower pots... can all be printed in half the usual time. PrusaSlicer comes with presets for both 0.8mm and 0.6mm nozzles, simply switch the **Printer** setting to "Original Prusa i3 MK3S+ 0.8 nozzle" or "Original Prusa i3 MK3S+ 0.6 nozzle" respectively.

7.3.1.2 0.25 nozzle by E3D

The nozzle diameter has a noticeable effect on the printing resolution of the plane parallel to the print surface. To get finer detail on 0.1mm or 0.05mm print settings, you can use a 0.25mm nozzle. But use it for only very small objects, e.g. a few centimeters in size. The print time can be considerably longer compared to 0.4mm. The ideal use is for jewelry. PrusaSlicer comes with presets for 0.25mm nozzle, simply switch the **Printer** setting to "Original Prusa i3 MK3S+ 0.25 nozzle".

7.3.1.3 Hardened steel nozzle by E3D

Hardened steel nozzles are a must for **highly abrasive materials**. Regular brass nozzles will degrade very quickly and lose their properties.

Most of the abrasive materials are composites, plastics with additives. Some examples are ColorFabb XT CF20, ColorFabb Bronzefill, ColorFabb Brassfill and some glow-in-the-dark filaments. Always ask your filament vendor if you are not sure. A slight disadvantage is that some standard materials like ABS are not able to be printed as fast as with a regular nozzle.

7.3.1.4 The Olsson Ruby nozzle

Similarly to the hardened steel nozzle, the Olsson Ruby is designed to print highly abrasive materials. However, since most of it is made from brass, it retains the excellent heat conductivity and throughput of the stock brass nozzle. Even though the ruby gemstone is highly wear resistant, it's also brittle. If you have your Live Z adjust set incorrectly (extremely low - big negative number) or if you misalign your SuperPINDA probe and the nozzle hits the removable steel sheet, it may crack. Do not overtighten the nozzle (1 Nm max).

7.3.2 Original Prusa Multi Material Upgrade 2S

Multi Material Upgrade 2S is the successor to the second generation of our unique addon, which enables your 3D printer to print with up to 5 colors at the same time.

Now compatible with the Original Prusa i3 MK2.5S and MK3S+ 3D printers, the MMU2S went through a major revision, resulting in a simpler and more reliable design. The number of simultaneously supported filaments increased to the total of five, which enables the users to print even more complex and more colorful objects.

MMU2 and MMU2S units are almost the same, but the printer extruder is equipped with a new filament sensor mechanism, which improved the reliability of the MMU2S unit. Thanks to the new design and placement of the filament sensor, the MMU2S unit now has feedback, that the filament is loaded into Bondtech gears. In addition, the filament length calibration is no longer required.

MMU2S comes with a redesigned body and a new filament loading mechanism. Instead of the previous Bowden system on the MMU1, the new unit uses a direct-drive feed and a single PTFE tube to lead the selected filament to the extruder. The motorized selector head has a F.I.N.D.A filament sensor and a built-in blade, which prevents filament jamming.

To unlock the full potential of the MMU2S, use our latest PrusaSlicer slicing software, which comes with new features, such as Smart wipe tower, Wipe into infill or Wipe into object.

To learn more, visit the official website <https://www.prusa3d.com>

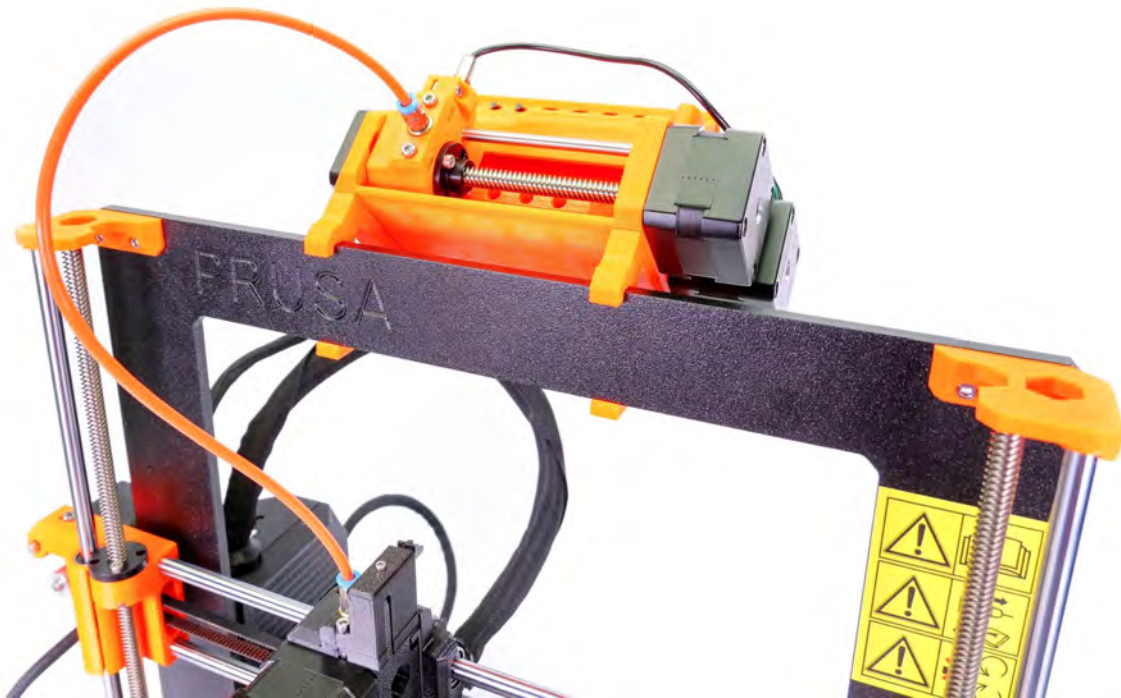

Pict. 23 - Multi Material Upgrade 2S mounted on the Original Prusa i3 MK3S+

7.3.3 Connecting Raspberry Pi Zero W

Raspberry Pi Zero W can be connected to the accessory header of the printer motherboard (EINSY) which will provide power and a serial data line for communication. After the connection, you can run applications like OctoPrint (octoprint.org) or Repetier Server (www.repetier-server.com/) to control the printer via a web browser interface.



PowerPanic functionality will not work with OctoPrint as of now, but Prusa Research is working with OctoPrint developers on implementing it.

You can always find up-to-date, **detailed instructions on how to connect the Raspberry Pi Zero W** at help.prusa3d.com. This walkthrough includes information about purchasing necessary components, printer disassembly, assembly, and configuration.

8 Advanced Calibration

Additional calibration tools and settings for advanced users are available, but they are entirely optional and some of them are even experimental.

8.1 Steel sheet profiles

The Smooth PEI sheet, Satin powder coated sheet and the Textured PEI powder coated sheet all have their advantages, as explained in [6.3.2 Preparation of spring steel sheet](#). It's possible you own all of them and wish to switch between them based on your current needs.

However, due to a different thickness of the sheets, each sheet requires individual First layer calibration. To avoid re-calibrating every time you switch the sheet, you can save the settings for up to 8 sheets. You can then easily switch between the sheets (profiles) and the printer will load the stored values.

To set up an individual sheet profile, head to the **LCD Menu - Settings - HW setup - Steel Sheets**. For each sheet, the following settings are available:

- **Select** - confirms the selection of the sheet, which will then become the default
- **First layer calibration** - starts the First Layer Calibration process for the given profile
- **Rename** - enables you to change the name, up to seven characters
- **Reset** - sets the values back to the factory defaults

As soon as two or more profiles are configured (by the [First Layer Calibration](#)), you will be able to quick-toggle between them directly from the main menu.

8.2 Nozzle diameter setup

By default, all Original Prusa i3 printers are shipped with the 0.4mm nozzle. In case you change the nozzle, you can set the correct diameter in **LCD Menu - Settings - HW setup - Nozzle d**. The printer will then compare the stored value of the nozzle diameter with parameters in the G-code. If there is a mismatch, you will be informed to prevent a print failure.

8.3 PID tuning for Hotend (Optional)

If you are experiencing wide swings in temperatures of your nozzle (e.g +/- 5 C°), you shall do PID tuning on your printer. *If you are experiencing major temperature fluctuations higher than that, first check that your hotend thermistor is properly seated in the heater block and plugged into your EINSY board.*

You can find this feature in **LCD Menu - Calibration - PID calibration**. In this menu, you have the option to choose the temperature for which the PID will be run. Set the temperature with which you print the most as it will tune itself ideally for the selected temperature. However, the general stability will improve for all temperatures (PLA/ABS/PETG). After that,

the nozzle will heat up to the set temperature in 5 cycles. During the cycles it is mastering the amount of power needed to reach the temperature and maintain it.



Do not touch the nozzle during this process until the process is fully finished as it will reach high temperatures!

Be aware that PID tuning is not a solution to all of the temperature fluctuation issues. Always make sure that your printer is located in a room with stable ambient temperatures; more information can be found at **Thermal Runaway and Temperature Drops** at help.prusa3d.com.

8.4 PINDA probe calibration / Temp. calibration (Experimental/Optional)



This chapter covers the MK3/S with PINDA v2 sensor only. If you have the Original Prusa i3 MK3S+ with SuperPINDA or if SuperPINDA is detected by firmware, the Temperature Calibration option in the menu will be disabled automatically.

All induction proximity probes drift the sensing distance with increased temperature. This might affect the quality of the first printed layer. PINDA v2 probe, included in the MK3S, has an embedded thermistor inside its body to measure the temperature and fully compensate for the drift. A pre-calibrated data table is stored in the printer and the temperature calibration is active by default.

You can re-calibrate the data table from the menu; it can be found in **LCD Menu - Calibration - Temp. calibration - Calibrate**. Before you do so, please make sure that your nozzle and heatbed are perfectly clean as the extruder will be moving around the heatbed during this process. This procedure must be done in a place with normal room temperature around 21°C/69°F.



Do not touch the nozzle or heatbed during this process until the process is fully finished as it will reach high temperatures!

Once calibrated, your PINDA v2 probe will be comparing its data readings under different temperatures and also, additionally, it will include your Live Z data. This should help you to have a stable Live Z.



Nevertheless, make sure that your 1st layer is done properly. More about that in [6.3.10. Fine-tuning the first layer](#).

8.5 View XYZ calibration details (Optional)

This feature can be found in **LCD Menu - Support - XYZ cal. Details** and provides access to more detailed info about XYZ calibrating results. The 1st screen tells you the distance of the “perfect” position of your two front calibration points. Ideally, all of these are positive and at least 10 mm or more. **When you get your axes perpendicular or slightly skewed, nothing needs to be tweaked because the printer will perform with the best accuracy.**

```
Y distance from min:
Left:  11.89 mm
Right: 11.82 mm
```

Pict. 24 - Distance of the front calibration point from the axis start.

Pressing the button will get you to the 2nd screen. This screen will identify how far you are from the perfect perpendicularity. It is measuring the skew of your X/Y axis.

*Up to 0.25° = **Severe skew compensating** for offset of 1.1 mm on 250 mm length*

*Up to 0.12° = **Slight skew compensating** for offset of 0.5 mm on 250 mm length*

*Under 0.12° = **No need to compensate**, X/Y axes are perpendicular. Congratulations!*

8.6 Linear Advance

Linear advance is a technology that predicts the pressure build-up in the extruder when printing at higher speeds. Firmware of the printer uses that prediction to decrease the amount of filament extruded just before stopping and decelerating, which prevents blobs or artifacts at the sharp corners. **If you are using PrusaSlicer, Linear Advance is already set up in the filament profiles.** MK3S+ features Linear Advance 1.5 starting with firmware 3.9.0. It is recommended to re-slice older G-codes.



If you are using different slicers from PrusaSlicer, or you just want to tweak and play around with different values, you can manually change the settings in g-code script.

However, if you do not understand the concept of G-codes yet, or never played with editing it, stop reading here and skip to another chapter.



The recommended K values (the parameter affecting how much Linear Advance affects the print) for each material and more instructions can be found [in the article at help.prusa3d.com](https://help.prusa3d.com).

8.7 Extruder info

Extruder info can be found in **LCD Menu - Support - Extruder info**. It provides debug information about the function of the fans. Exact RPM may vary, but any major change, or a zero value, is an indication of a problem.

- **Nozzle FAN RPM**
- **Print FAN RPM**

8.8 Sensor info

This menu can be found in **LCD Menu - Support - Sensor info**. It provides information about:

PINDA - [0, 1] Induction sensor placed on the extruder body. If the sensor detects a metal object (such as the steel sheet) it shows a value of 1 (triggered).

FINDA - [0, 1, N/A] Induction sensor used on the MMU unit selector. Value 1 means that the presence of filament is detected. If MMU2S is not connected, the status value is N/A.

IR - [0, 1] Infrared filament sensor placed on the extruder body. Value 0 means that filament is not detected. Value 1 means that the presence of filament is detected.

Starting with firmware 3.9.0 and filament sensor v0.4 (or newer), the printer now has more options how to recognize correct operation of the filament sensor. If you have the red PCB sensor (revision 0.4), the printer can recognize an issue with cable connection and react accordingly. You can find more information at help.prusa3d.com.

8.9 Display brightness

This option first became available in firmware 3.9.0 and can be found in *LCD Menu - Settings - Brightness*. It allows you to lower the screen brightness. This function is only available for printers manufactured in second half of 2019 and newer. With older printers, you have to replace the LCD screen and also in some cases the Einsy board (Einsy 1.1a or newer is required).

9 Printer drivers

The latest drivers and information can be found at www.prusa3d.com/drivers.

The driver package contains the following settings and programs:

PrusaSlicer - converting 3D models into .gcode format for printing.

Pronterface - legacy printing from a computer (in case you don't want to print from the SD card)

NetFabb - repairing corrupted or unprintable models

Settings - optimizing print settings for Cura, Simplify3D and KISSlicer

Drivers for Prusa i3 printer - Windows drivers

Test objects

10 Creating and printing your own models

10.1 Where can you get the 3D models?

The best way to get started with your own 3D printing is to find already-created models on the internet - they should be in the **.stl** or **.obj** format. Fortunately, there are a lot of fans and there are sites from which you can download a large variety of ready-made 3D models - ranging from a simple shaver holder to a detailed aircraft engine model.

3D models are generally free to download under the **Creative Commons - Attribution - Non Commercial** (models cannot be used commercially, credit the author when you share the model). We have selected the most interesting sites with high-quality models:

1. <https://www.printables.com>
2. <http://www.thingiverse.com/>
3. <https://www.myminifactory.com/>
4. <https://pinshape.com/>
5. <https://www.youmagine.com/>
6. <https://cults3d.com/>

10.1.1 Printables

Printables.com (formerly PrusaPrinters.org) is a **large online library of high-quality 3D models** managed by Prusa Research. The main goal is to bring together a large active community of designers, makers and 3D printing enthusiasts - no matter which 3D printer brand they prefer. There are **regular community contests** with 3D printers and filaments as the top prizes and there's also a **reward system with both virtual and physical goods** - simply by being an active member, you can **collect points and exchange them for a spool of Prusament or cool merchandise**.

With the focus on high-quality, unique and useful models, you are **always just a few clicks away from discovering something new and amazing to print**. And before you actually download and print something, you can use an **advanced built-in 3D model viewer** that works with not only STL and 3MF files, but G-Codes as well.

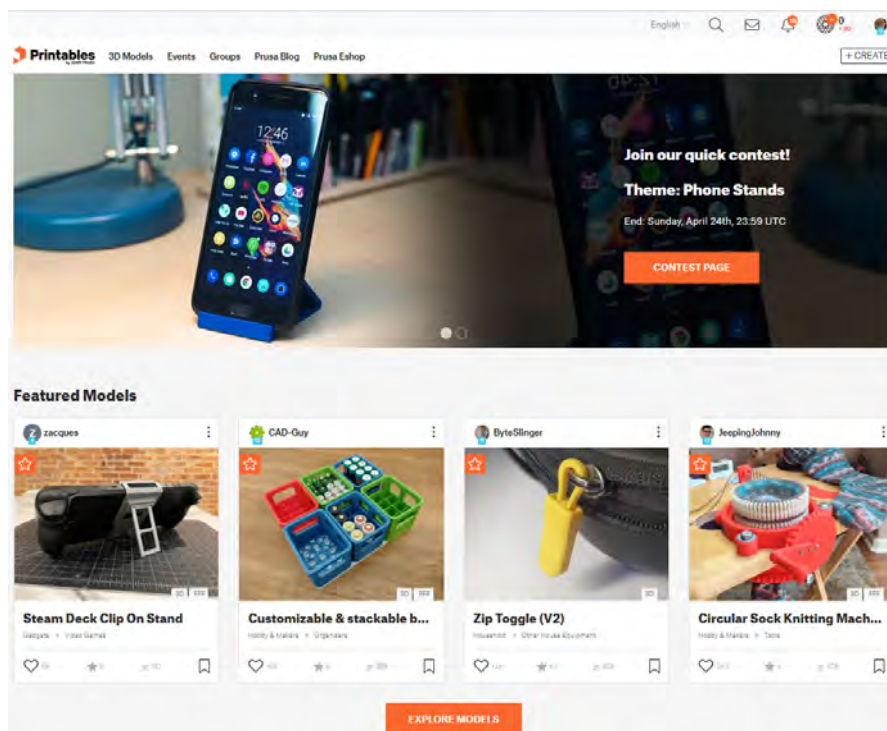

10.1.2 Bundled 3D models

We asked a couple of known 3D designers to prepare some printable objects for you to print. They are ideal for the first prints on your new printer. STL and G-code files are available after installing the drivers package in the “3D Objects” folder, or bundled on your SD card. You can check them out at <https://www.prusa3d.com/printable-3d-models/>.



Pict. 25 - the 50-microns treefrog is commonly used as a 3D printing benchmark.

10.2 In what program can you create your own models?

To create a 3D model yourself, you need a dedicated program. The easiest way to quickly create a model is TinkerCad (www.tinkercad.com) - an online editor (no installation needed) - where you create your 3D model directly in the browser window. It is free, easy to operate and you will find even basic video tutorials, so after a few minutes, nothing prevents you from creating your first 3D object.

Another popular tool for creating models is **Fusion 360** (<https://www.autodesk.com/products/fusion-360/>) for PC, Mac and iPad. The website provides a quick guide along with detailed video tutorials so it is an ideal choice for novice enthusiasts.

There is a great deal of 3D programs - free or paid - your choice depends more on your personal taste and preferences. The following is a list of other programs used for making 3D models: OpenScad, DesignSpark Mechanical, Blender, Maya, 3DS Max, Autocad and many more...

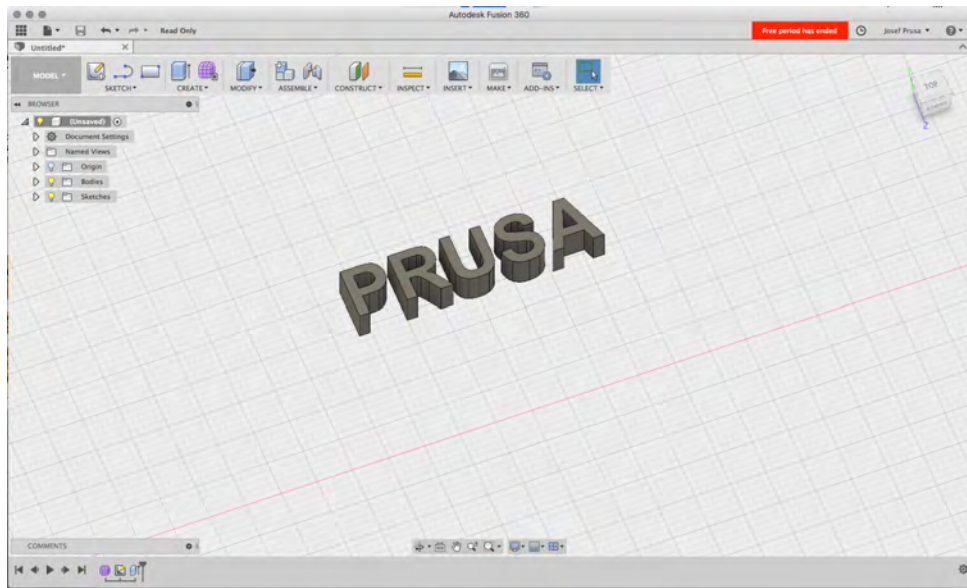

Pict. 26 - Fusion 360

10.3 Modeling with 3D printing in mind

Modeling for 3D printing presents several interesting challenges.

10.3.1 Overhangs and support material

The most important thing to keep in mind while modeling for 3D printing is support material. 3D printers can't print in mid-air, each layer has to be laid on top of the previous layer. When designing, keep this limitation in mind and try to avoid creating steep overhangs. That said, short horizontal bridges can be printed without supports.

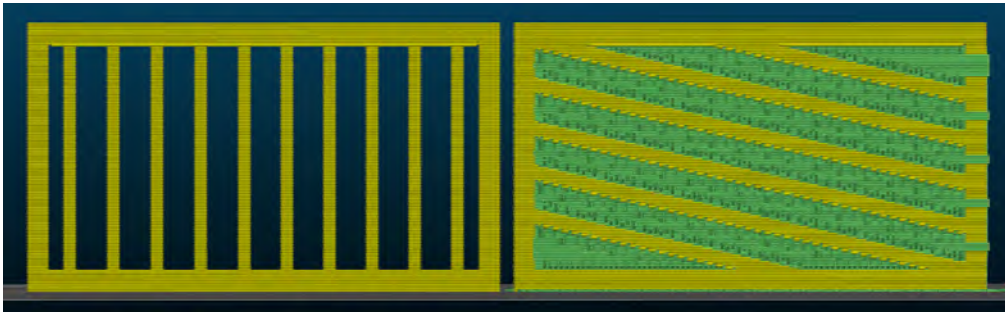

Pict. 27 - Model printable without supports vs model that needs a lot of supports

10.3.2 Fillet vs chamfer

If oriented towards the print bed, fillets create a very steep overhang, which negatively affects the surface of the object. For this reason, **use chamfer instead** if perfect part finish is the priority.

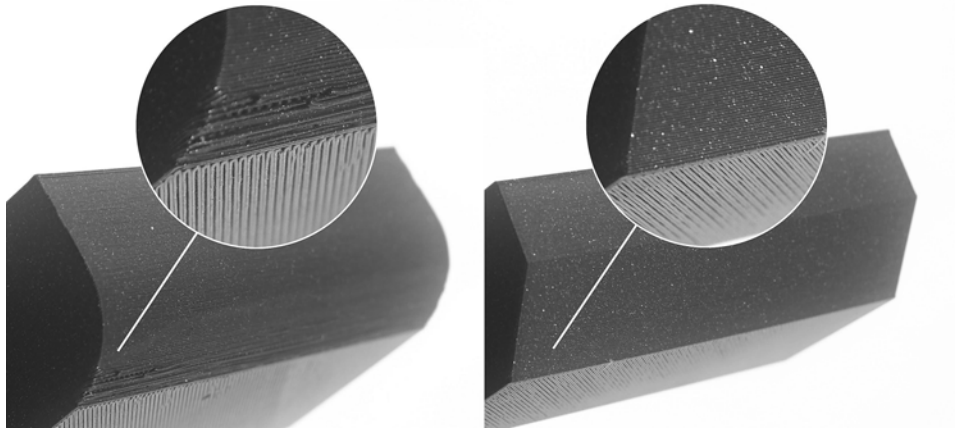

Pict. 28 - Fillet (left) vs chamfer (right)

10.3.3 Thin walls and minimum feature size

Another limitation is the nozzle diameter. The default nozzle size is 0.4 mm with **extrusion width of 0.45 mm**. Keep this number in mind, especially when you're designing thin walls or tiny features.

Wall thickness	Is it printable?
Less than one perimeter	
One perimeter	
More than one perimeter, but less than two perimeters	
More than two perimeters	

10.3.4 Splitting model into multiple parts

Both visual and mechanical properties of your model can be improved by splitting it into multiple parts. It's often better to split a complex object into multiple parts that are easier to place on the print platform. This way, you can minimize the number of supports required. You can then glue the object together.



Pict. 29 - A sphere printed in two separate parts glued together

10.3.5 Tolerances

When you design multiple parts that are supposed to fit into each other, you have to add a small tolerance (a gap). For example, if you want a cylinder to fit inside a circular hole, the cylinder's diameter needs to be at least 0,1 mm smaller. The good thing about 3D printing is that you can quickly iterate and try which tolerance works best for your application.

Tolerance	Fit
0,1 mm	Very tight
0,15 mm	Tight
0,20 mm	Loose

11 Slicing

When you download 3D models from the internet or create your own models, you will need to convert the 3D model (.stl, .obj.) into a set of instructions for the printer called **G-code**. G-code is a file format readable by 3D printers. The file contains information such as nozzle movement, the amount of filament to extrude, temperature settings or fan speeds. There are dozens of slicers available, each with their own advantages and disadvantages. The three most commonly used slicers among the prusa printer owners are:

- **PrusaSlicer (recommended)**
- Cura
- Simplify3D

11.1 PrusaSlicer

As the name suggests, PrusaSlicer is our own in house developed slicer based on the open-source project *Slic3r*. It has many useful features such as:

- ✓ Ready to print, auto-updating profiles for over 3 dozen filaments
- ✓ Variable layer height
- ✓ Custom supports and modifier meshes
- ✓ Differential print settings
- ✓ Firmware flasher

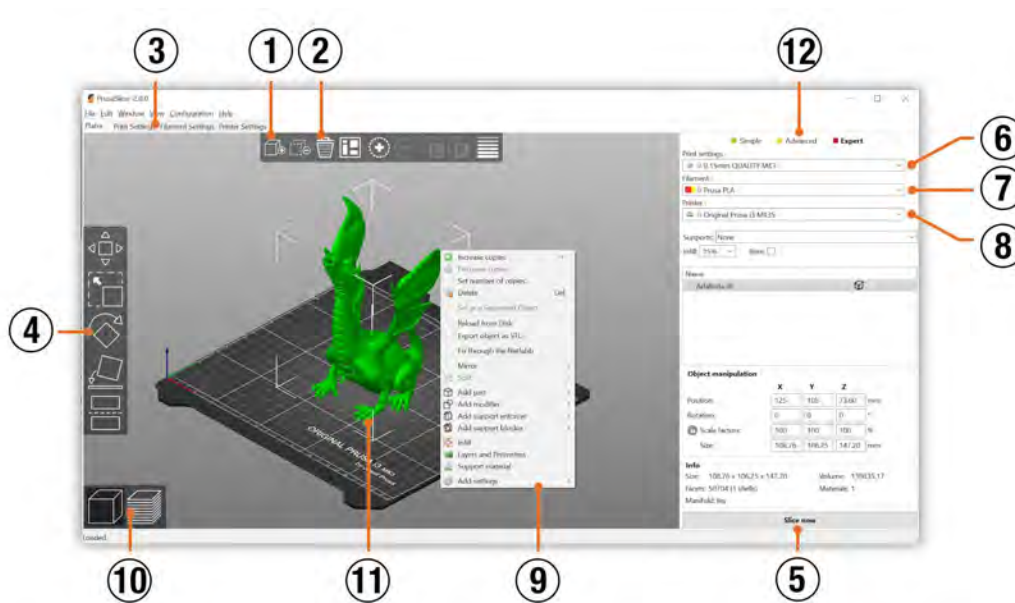

Pict. 30 - PrusaSlicer interface

1. The **Add** button loads models into PrusaSlicer
2. **Delete** and **Delete All** buttons remove the model(s) from PrusaSlicer
3. Opens the detailed settings of print, filament and printer
4. Move, scale, rotate, Place on Face and cut tools
5. Slice and generate **.gcode** button
6. Quality / Speed setting of a print
7. Material selection
8. Printer selection
9. Right-click on model opens a context menu
10. Switch between 3D editor and layers preview
11. Model preview
12. Switch between Simple / Advanced / Expert mode

 The in-depth and up-to-date documentation of the PrusaSlicer, including a glossary and advanced tips, can be found at help.prusa3d.com/prusaslicer

11.2 Printing of non-standard models

PrusaSlicer has built-in tools for printing non-standard models such as models with overhangs and/or models larger than the printing bed.

11.2.1 Printing with support material

If you print an object with a gradient lower than 45°, the resulting overhang would be preventing the object to be printed correctly. PrusaSlicer allows you to print such objects thanks to the 'Printing with support' function. Support material is an extra structure printed as scaffolding for the object - you can remove the support material after the printing is finished.

Choose the *Print Settings* tab (1) and click the *Support Material* option (2) in the left column. First, you have to check the *Generate support material* box (3). Next item - *Overhang threshold* (4) lets you set the minimal angle for the printing of the support material. Setting this item to zero lets the printer detect problematic parts automatically and print supports where needed. *Enforce support* option (5) is used mostly with small models or models with a small base to prevent the object from breaking or tearing out from the bed.

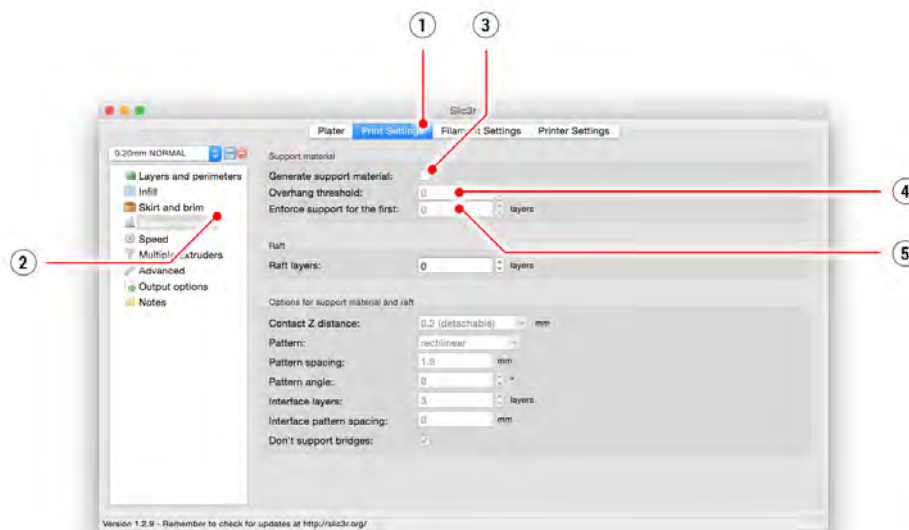

Pict. 31 - Print with support menu

11.2.2 Large object printing

Another special case is when you want to print objects larger than the heatbed. The first option is to resize the object to a printable size. Select the **Scale** tool from the left menu (or press the **S** key). Then use the 3D gizmo to change the scale of the object. If you want to scale the model uniformly, drag the scale gizmo by one of its corners.



The in-depth and up-to-date documentation of the PrusaSlicer, including a glossary and advanced tips, can be found at help.prusa3d.com/prusaslicer

You can also change the size of a model along one of the axes by dragging the corresponding gizmo handles. Alternatively, you can use the object manipulation window in the bottom right corner to type in an exact scale value.

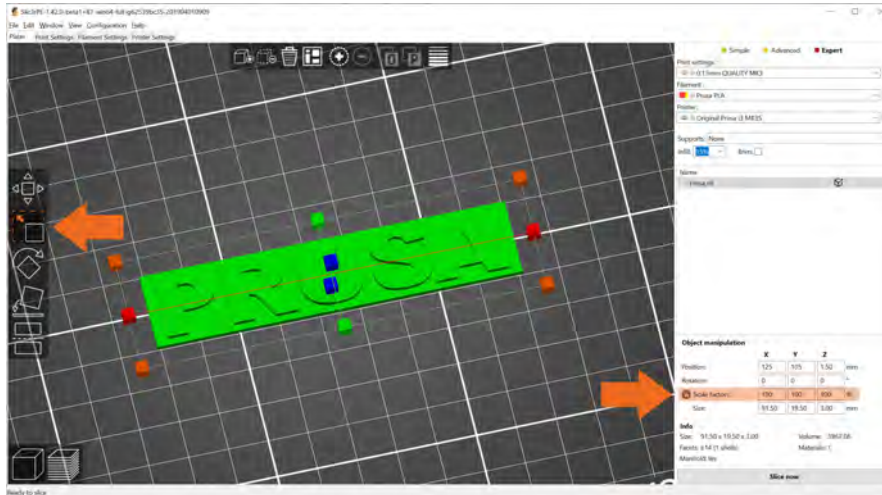

Pict. 32 - Changing the scale of a printed object

If you need to print an object that does not fit the printer at its original scale, you have to cut the object into smaller pieces. Select the **Cut tool** from the left menu (or press the **C key**). Position the cut plane to the desired position or enter a precise height into the Cut dialog window. You can decide whether you want to keep the upper, lower or both object parts.

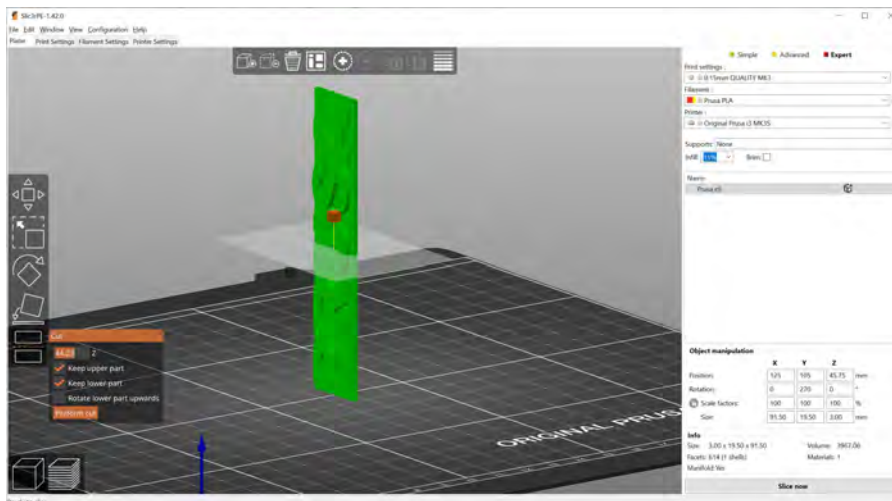

Pict. 33 - Cutting the object with the Cut option

11.3 Print in color with ColorPrint

There is a simple way to create layer-based multi-colored 3D prints either directly in PrusaSlicer or with our simple online ColorPrint app.

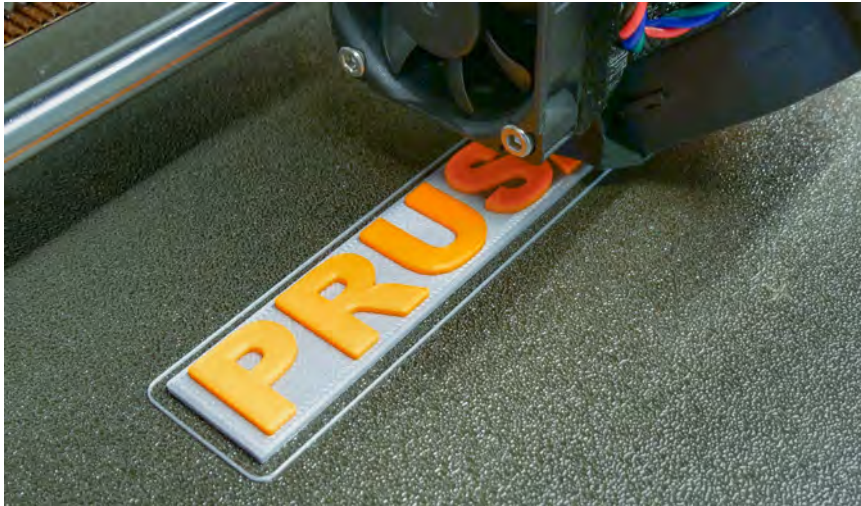

Pict. 34 - Multicolored object printed with ColorPrint

Color change in PrusaSlicer

1. Switch to the layer preview using the button in the lower left corner
2. Using the slider on the right side, select a layer where the color change should occur
3. Click on the **orange plus icon**
4. A preview is instantly displayed. You can remove the color change by clicking on the grey cross button that is now displayed instead of the orange plus button
5. Export the G-code and you're ready to print!

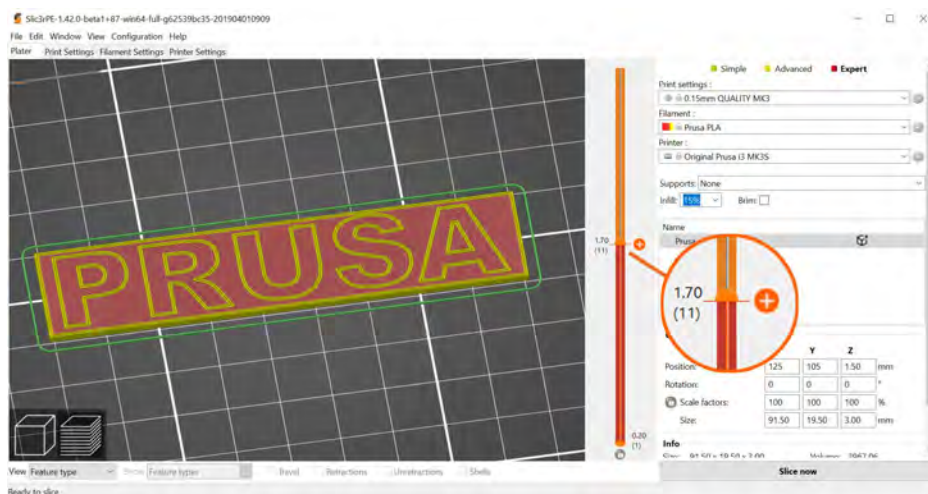

Pict. 35 - Setting up color change in PrusaSlicer

Color change using the ColorPrint web app

1. First of all, you need to prepare regular **G-code** with common print and filament settings. Save the file.
2. Then go to <https://blog.prusa3d.com/color-print>
3. Drag the G-code to the frame and click on **Add change** button.
4. Find the **height** of the layer where you want to make the color change. This can be easily found in PrusaSlicer under tab "Layers." The scale along right side displays the height of individual layers. Set this number to the box. The number of these changes is unlimited.
5. When you are done with your modification, download the file. This file is **ready** to be printed!

Insert the filament which you want to start with into your printer and start printing the file.

When the color change is triggered from the g-code, the printer will follow this simple procedure:

- Stop moving and retract
 - Raise the Z by 2 mm and move quickly outside the printbed
 - Printer will start beeping and prompt user to unload the current filament
 - Then you'll be asked to insert the new filament. When you do so and continue, the filament will be pulled into the hotend and LCD will display "**Changed correctly?**" with three options:
1. "**Yes**" Everything went ok and printing can continue. Check if the new color is clear without any remains of the previous filament - if so, choose this option to continue printing with a new color.
 2. "**Filament not loaded**" If the new filament was not loaded properly, choose this option and the printer will start the automatic filament load again. When the filament is loaded properly, you can choose the "Yes" option and the printing will continue with a new color.
 3. "**Color not clear**" Filament was loaded but the color is still mixed with the previous filament. Press the button with this option and the printer will extrude more filament from the nozzle. When the color is pure without any remains of the previous filament you can choose the "Yes" option and the printing will continue with a new color.

After confirming, the printer returns to the original position and continues to print.

 Another option for **multicolored print** is to use the filament change option. Choose the **Tune** and then **Change filament** option during the print. The printer will pause the printing process, unload the filament and signal you to insert the new filament.

The procedure is the same as above.

 You should always use the same material or combine materials with similar print temperatures and settings.

12 Materials

Materials in this chapter are sorted from the most to the least commonly used. If you're new to 3D printing, your first filament should definitely be PLA. Only when you are limited by some of PLA's disadvantages, it's time to try other filaments like PETG or ASA. Other materials listed here are very specific to a particular application.









You can find a comprehensive filament guide at help.prusa3d.com/materials. It contains a table describing all sorts of supported filaments, divided both by material and specific manufacturers. You can compare their parameters starting with physical properties and ending with their prices. Filaments can be sorted and filtered by their parameters and intended use.





12.1 PLA

PLA is the most commonly used material for 3D printing. It is **easy to print with**, and PLA prints are **very hard**. The perfect choice for printing large objects due to low thermal expansion (prints do not warp on the heatbed) and for printing small detailed models. **It is the only material that is well suited for printing 50 micron layers** (Ultradetail resolution).

Advantages

-  Easy to print
-  Detailed prints of small models
-  Trouble-free printing of large objects
-  Hard, low flexibility
-  Almost odorless
-  Affordable
-  Wide color selection

Disadvantages

-  Brittle
-  Low-temperature resistance (60 °C)
-  Difficult to post-process
-  Not suitable for outdoor use

Typical use

- prototypes
- toys
- figures
- jewelry (tiny and detailed models)
- architecture models

Tips and tricks

When post-processing PLA, it's better to use wet sanding. Without water you'll quickly start heating the plastic by friction, it will melt locally and make it hard to keep sanding. PLA is only soluble in chemicals like chloroform or hot benzene. So when connecting multiple pieces, you're better off using superglue or acetone.

- **Nozzle temperature:** 215 °C
- **Bed temperature:** 50 - 60 °C
- **Heatbed:** Make sure the surface is clean, as described in [6.3.2 Preparation of spring steel sheet](#)

12.2 PET/PETG

PETG is another commonly used material for 3D printing. It is a great choice for printing **mechanical components**. Compared to PLA, it has **higher temperature resistance**, is more **ductile** and therefore **less brittle**. Due to its low thermal expansion it holds well on the heatbed and **does not warp**. Printing with it is almost as easy as with PLA. But unlike PLA, it can offer better mechanical properties. Parts for our printers are printed from PETG!

Advantages

- ✓ High-temperature resistance
- ✓ Easy to print
- ✓ Low thermal expansion
- ✓ Ductility and strength
- ✓ Easy sanding
- ✓ Almost odorless
- ✓ Glossy surface
- ✓ Perfect layer adhesion
- ✓ Water and humidity resistant
- ✓ Recyclable

Disadvantages

- ✗ Not suitable for printing small models
- ✗ Possible stringing
- ✗ Bridging is problematic
- ✗ Strong adhesion to the printbed
- ✗ Cannot be smoothed with acetone
- ✗ Supports can be difficult to remove

Typical use

- mechanical components
- holders and cases
- watertight prints (pots)

Tips and tricks

Unlike PLA or ABS, PETG tends to ooze a bit and may leave **strings of plastic** on your print. You can fight this by increasing retraction and playing with hotend temperature. But if you use our presets in PrusaSlicer, we already did that for you and the amount of stringing is minimal. If you witness a tiny bit of stringing anyway, you can get rid of it by quickly blasting your finished prints with a heat gun. PETG is often referred to simply as PET. Generally, they're almost the same material (you can even get pure PET filament, but it's difficult to print with).

- **Nozzle temperature:** 240 °C

- **Bed temperature:** 80 - 100 °C
- **Heatbed:** Make sure the surface is clean, as described in [6.3.2 Preparation of spring steel sheet](#) chapter (**extra important with PETG**, risk of damage to the Smooth PEI sheet if treated incorrectly)

12.3 ASA/ABS



ASA and ABS are very similar materials. ASA is many ways even better than ABS and can be considered a successor to ABS. ASA is UV stable compared to ABS (less yellowing) and shrinks somewhat less when printed. The only advantage of ABS is the easier surface treatment with acetone. Going forward, we will only talk about ASA, but the same goes for ABS.

ASA is a strong and versatile material. A higher melting point than PLA gives ASA excellent heat resistance, your prints will not show signs of deformation up to around 100 °C. Unfortunately, ASA has a very high thermal expansion compared to PLA, which complicates printing, especially for larger models. Even with a heated bed set to 100 °C, the print can begin to warp and peel off the bed. The material also produces an unpleasant odor during printing.

Advantages

- ✓ High impact and wear resistance
- ✓ Very good temperature resistance
- ✓ Suitable for outdoor use - UV stable
- ✓ Soluble in acetone - easy to glue together
- ✓ Can be smoothed with acetone vapors

Disadvantages

- ✗ Difficult to print
- ✗ Tendency to warp
- ✗ Worse detail resolution
- ✗ Unpleasant odor during printing

Typical use

- covers and protective cases
- prototypes
- replacement parts
- toys and figures

Tips and tricks

Printing with ASA/ABS is much easier when done inside an **enclosure**. The heated bed will quickly heat the enclosure and reduce the thermal shock on the extruded filament. As a result, both warping and layer separation is decreased significantly.

Acetone makes it easy to glue multiple prints together. All you have to do is rub the contact surfaces lightly with acetone and press the parts together. In addition, prints can be smoothed with acetone vapor to give a perfectly glossy finish. You have to be careful when handling acetone, but it is not nearly as dangerous as PLA solvents.

- **Nozzle temperature:** 245 - 265 °C

- **Bed temperature:** 90 - 110 °C. (a larger object requires a higher temperature)
- **Heatbed:** Make sure the surface is clean, as described in [6.3.2 Preparation of spring steel sheet](#) chapter. Apply a thin layer of glue stick when using the Textured PEI powder coated sheet.

12.4 PC Blend (Prusament)

Polycarbonate (PC) is a technical material with great tenacity, tensile strength, and heat resistance. However, it's very hard to print, therefore suitable mainly for advanced users. However, this doesn't apply to our Prusament PC Blend, which is significantly easier to print compared to other polycarbonates.

Polycarbonate requires some experience to print properly. If you are a beginner, consider experimenting with easier materials like PLA or PETG first.

Advantages

- ✓ High-temperature resistance
- ✓ High impact tenacity and tensile strength
- ✓ Good electric insulation properties

Disadvantages

- ✗ High warping, especially with large models

- **Nozzle temperature:** 275 °C
- **Bed temperature:** 110 °C for the first layer, 115 °C for other layers
- **Heatbed:** Apply a thin layer of glue stick when using the Smooth PEI sheet or the Satin powder coated sheet.

12.5 Flex

Flex is a very strong and elastic material. In many cases, classic hard plastics may not be suitable for printing a specific model. Whether you are printing a phone cover, an action camera case, or an RC car wheel, it is better to use a flexible material.



Before you print from Flex, clean the nozzle from any previous material. Start by preheating to the highest temperature you've recently printed at. Then load PLA into the extruder to push out any previous material. When inserting Flex, loosen the pressure on the idler as much as possible.

Advantages

- ✓ Flexibility and elasticity
- ✓ Minimal warping
- ✓ Good layer adhesion
- ✓ Abrasion resistance

Disadvantages

- ✗ It requires extra steps to load the filament
- ✗ More demanding to prepare and print
- ✗ Must be printed slowly
- ✗ Higher price
- ✗ Must be stored in a dry environment

- **Nozzle temperature:** 230 - 260 °C
- **Bed temperature:** 45 - 65 °C (a larger object requires a higher temperature)
- **Heatbed:** Make sure the surface is clean, as described in [6.3.2 Preparation of spring steel sheet](#) chapter. **WARNING:** Some very soft materials can adhere very strongly to the **smooth PEI sheet and Satin powder coated sheet require the use of a glue stick** as a separator to avoid damaging the PEI surface. This is not necessary with the textured powder-coated PEI.

12.6 CPE (copolyester)

CPE (copolyester) is a special material similar to PETG. The material was designed for easy and high-quality printing with mechanical properties that surpass standard PETG material. Like PETG, it does not deform when printed and does not cause any unpleasant odor. It's chemically resistant and has excellent layer adhesion.

Advantages

- ✓ High strength and tensile strength
- ✓ Great for mechanical parts
- ✓ Excellent layer adhesion

Disadvantages

- ✗ Not soluble in acetone
- ✗ Somewhat abrasive
- ✗ Must be stored in a dry environment

- **Nozzle temperature:** 255 - 275 °C
- **Bed temperature:** 70 - 90 °C (a larger object requires a higher temperature)
- **Heatbed:** Make sure the surface is clean, as described in [6.3.2 Preparation of spring steel sheet](#) chapter. Apply a thin layer of glue stick when using the Smooth PEI sheet.

12.7 Nylon (Taulman Bridge)

Nylon is a very strong, ductile and versatile material suitable especially for mechanical components. It is flexible in thin layers but with very good adhesion between layers. Nylon must be stored in a dry environment. Otherwise, it quickly absorbs air humidity and bubbles form in the material. Dry nylon filament prints smooth objects with a glossy finish.

Advantages

- ✓ Mechanical properties
- ✓ Chemical resistance
- ✓ Flexible, but strong

Disadvantages

- ✗ Must be stored in a dry environment
- ✗ Somewhat difficult to print
- ✗ May warp

- **Nozzle temperature:** 240 °C
- **Bed temperature:** 80 - 90 °C.
- **Heatbed:** Do not print on the smooth PEI sheet. Apply a thin layer of glue stick on the Satin and Textured powder coated sheets.

Typical use

- screws, nuts
- replacement parts
- gearboxes

12.8 XT (ColorFabb)

The XT by ColorFabb is tough and ductile. The prints do not warp, have good temperature resistance and a glossy finish.

Advantages

- ✓ Higher temperature resistance (up to 80 °C)
- ✓ Food safe
- ✓ High toughness and ductility
- ✓ Almost odorless when printing

Disadvantages

- ✗ Slightly worse bridging
- ✗ Higher price

- **Nozzle temperature:** 240 - 260 °C
- **Bed temperature:** 60 - 90 °C (a larger object requires a higher temperature)

- **Heatbed:** Make sure the surface is clean, as described in [6.3.2 Preparation of spring steel sheet](#) chapter. Apply a thin layer of glue stick when using the Smooth PEI sheet.

12.9 HT (ColorFabb)

HT filament, Amphora copolyester is suitable for demanding users who require durability and high thermal resistance of the material up to 100 ° C. Suitable for printing functional prototypes.

Advantages

- ✓ High temperature resistance (up to 100 °C)
- ✓ High strength and ductility
- ✓ Odorless

Disadvantages

- ✗ Higher price
- ✗ Worse adhesion to the printed bed

- **Nozzle temperature:** 250 - 280 °C
- **Bed temperature:** 100 - 110 °C (a larger object requires a higher temperature)
- **Heatbed:** Make sure the surface is clean, as described in [6.3.2 Preparation of spring steel sheet](#) chapter. Apply a thin layer of glue stick when using the Smooth PEI sheet.

12.10 Composite materials

Composite materials (corkfill, copperfill, bronzefill, carbon or aramid composites and many others) are based on the main plastic medium and second material in the form of dust. These materials are very abrasive, so if you plan to print them long term, we recommend using a hardened nozzle. When using wood composites, we recommend larger nozzles (0.5 mm and larger). The printing characteristics of each material may vary depending on the plastic base, so use the appropriate print settings in the PrusaSlicer.

Postprocessing

The first step of polishing is sanding with sandpaper. It's better to start with a coarse one (80) and use finer and finer sandpaper. You can then sand the model with a brass brush. If you are still not satisfied with the polish of the material, you can finally use the wet sanding method with very fine sandpaper (1500+).

Advantages

- ✓ Great look after post-processing
- ✓ No warping

Disadvantages

- ✗ Requires a hardened nozzle
- ✗ May require a 0.6 mm nozzle

- **Nozzle temperature:** 190 - 210 °C

- **Bed temperature:** 50 - 70 °C (a larger object requires a higher temperature)
- **Heatbed:** Make sure the surface is clean, as described in [6.3.2 Preparation of spring steel sheet](#) chapter.

12.11 HIPS

HIPS is most commonly used as a support material in conjunction with ASA or ABS. HIPS material dissolves with lemonesol and leaves a smooth print with no marks after removing the supports.

Advantages

- ✓ Solubility of lemonesol
- ✓ Layer smoothness
- ✓ Lighter than ABS

Disadvantages

- ✗ Difficult to print
- ✗ Tendency to warp
- ✗ Odor when printing

- **Nozzle temperature:** 215 - 225 °C
- **Bed temperature:** 90 - 110 °C (a larger object requires a higher temperature)
- **Heatbed:** Make sure the surface is clean, as described in [6.3.2 Preparation of spring steel sheet](#) chapter.

Typical use

- Support material for ASA/ABS
- Protective cases

12.12 PVA and BVOH

These are water-soluble materials that are used to print supports for the most widely used PLA printing material. Support can be printed even in difficult-to-reach places and in complex models, where it is difficult or impossible to remove regular supports.

Advantages

- ✓ Water soluble
- ✓ No need for special solvents

Disadvantages

- ✗ Expensive
- ✗ Must be stored in a dry environment



Always store PVA and BVOH in a dry bag/box, ideally with silica gel. The material is highly hygroscopic!

- **Nozzle temperature:** 185 - 210 °C
- **Bed temperature:** 40 - 60 °C

12.13 nGen

NGen was developed by Eastman Chemical Company and colorFabb. It is very similar to classic PETG. It does not contain styrene.

Advantages

- ✓ Smooth surface
- ✓ Good layer adhesion

Disadvantages

- ✗ Brittle
- ✗ Slight warping

- **Nozzle temperature:** 240 °C
- **Bed temperature:** 80 - 100 °C (a larger object requires a higher temperature)
- **Heatbed:** Make sure the surface is clean, as described in [6.3.2 Preparation of spring steel sheet](#) chapter. Apply a thin layer of glue stick when using the Smooth PEI sheet.

12.14 PP

Polypropylene has very good mechanical properties, is partially elastic, can withstand higher temperatures than ABS or PLA and is resistant to many chemicals.

Advantages

- ✓ Ductile
- ✓ Partially elastic
- ✓ Temperature resistance

Disadvantages





- ✗ Tendency to warp
- ✗ Bad adhesion to the heatbed

- **Nozzle temperature:** 210 -230 °C
- **Bed temperature:** 95 - 100 °C.
- **Heatbed:** Do not print on the Textured PEI powder coated sheet. Use PP transparent adhesive tape, which you attach directly to the print surface when using the Smooth PEI sheet. Can be printed directly on the Satin powder coated sheet.

12.15 T-Glase (Taulman)

T-Glase is a high-strength printing material. It's temperature resistant up to 78 °C. Small shrinkage allows for printing of large objects.

Advantages

-  Great layer adhesion
-  Strong
-  Minimal warping
-  Odorless

- **Nozzle temperature:** 230 - 240 °C
- **Bed temperature:** 90 - 110 °C (a larger object requires a higher temperature)
- **Heatbed:** Make sure the surface is clean, as described in [6.3.2 Preparation of spring steel sheet](#) chapter. Apply a thin layer of glue stick when using the Smooth PEI sheet.

Disadvantages

-  Higher price

12.16 Creating profiles for new materials

Each manufacturer delivers a slightly different material, e.g. Prusament PLA and ColorFabb PLA have slightly different printing properties, even though they are both PLA. For some manufacturers, it may even happen that different colors of the same material behave differently.

For best results, you should **experiment with nozzle and heatbed temperature settings, fan speed, print speed, and material flow**. All of this can be adjusted while printing in the Tune menu on the LCD panel.

The same applies to materials for which we do not have a print profile. Take the recommended settings from the manufacturer, find the nearest material profile in PrusaSlicer, edit it and save it as new. **Proceed with test prints and adjust the settings one after another in the Tune menu.** Once you're happy with the print quality, save the settings directly to your PrusaSlicer profile.

Be sure to reset the values in the Tune menu before the next print!

If you are happy with the new settings, consider sharing it on the forum or directly with us at info@prusa3d.com.

13 FAQ - Printer maintenance and print issues

13.1 Regular maintenance

13.1.1 Bearings

Every couple hundred hours, the smooth rods should be cleaned with a paper towel. Then look for the white tube in the package and apply a little bit of the included lubricant on the smooth rods and move the axis back and forth a couple of times. This cleans the dirt and increases longevity. For a detailed maintenance guide, please head to help.prusa3d.com

If you feel the axis is not running smoothly anymore, bearings can be taken out and greased on the inside (they need to be removed from axis because the plastic lip will prevent most of the grease from getting inside).

13.1.2 Fans

Both fans should be checked and cleaned every couple hundred hours; dust or plastic build-up can decrease their efficiency or even damage them. Computer cleaner spray will get the dust away and tweezers can be used for little plastic strands.

Both extruder and part cooling fans measure current RPM (Revolutions Per Minute). Because of that, they can detect any problem that will cause the fan to slow down, like a piece of filament getting stuck in it. If you get a fan error, check that it can rotate freely; clear any debris that may be stuck in it.



Pict. 36 - Hotend cooling fan

```
U 67/0°      Z 0
M 55/55°     *100%
SD---%       0--!--
Err: EXTR.  FAN ERROR
```

Pict. 37 - Fan error

You can turn off the monitoring in **LCD menu - Settings - Check fans** for example if you replaced one of the fans with a replacement not supporting RPM sensing.

13.1.3 Extruder drive gear

The Bondtech Extruder gears on the extruder motor shaft can have build-up of filament shavings in the grooves and cause under-extrusion. A small brass brush is an ideal tool to clean the grooves, but a regular toothpick will do the job as well. Check and clean from the access window on right side of the extruder assembly. Clean what you can, then rotate the gear and repeat. Nothing needs to be disassembled. Clean when you see signs of missing plastic in the objects, e.g. missing lines of extrusion.

The Bondtech Extruder gears are made from hardened carbon steel. As the gear meshing section is constantly turning during operation it needs lubrication to reduce wear, lower the friction and to reduce noise. **A lithium based grease** is recommended to be used. **Oil is not recommended** since it might spread to the section where the filament is fed to the hotend. After extensive use it is recommended to remove, clean and inspect the gears. This is also a good time to also put some grease on the needle bearings in the secondary gear to keep the friction low.

13.1.4 Electronics

It is a good practice to check and eventually reconnect the electrical connectors on the EINSY RAMBo board. Do so every 600-800 hours of printing.

13.1.5 Smooth PEI sheet rejuvenation

The smooth PEI sheet can lose its adhesive powers after a couple hundred hours. Wipe it thoroughly with acetone when you see models getting loose to restore the adhesion. Note that this procedure is forbidden for the textured sheet, where it leads to permanent damage to the surface.

13.2 Print surface preparation

Print surface preparation is described in [6.3.2 Preparation of spring steel sheet](#) chapter.

13.3 Filament sensor

The new mechanical IR based sensor is more reliable than the optical filament sensor in the previous version Original Prusa i3 MK3. The filament sensor can detect running out of filament and is used for filament AutoLoad.

13.3.1 Running out of filament

Running out of filament **will no longer cause a print failure**. If you run out of filament, the printer will automatically pause the print, unload the remaining few centimeters in the heatbreak, and move the X-carriage away from the print. You will be prompted to replace the spool and insert a new filament. Use pliers to remove the filament extruded during the loading process. After that, you can continue in the **current print**.

13.3.2 False sensor readings and debugging

You can encounter false runout readings reported by the sensor. First step is to check if the filament sensor is working properly in **LCD menu - Support - Sensor info**. When you **insert filament** into the extruder, the IR state should be “1”. When you **unload and remove** the filament from extruder, the state should change to “0”.

Possible causes might be:

13.3.2.1 Wiring problem

If the sensor is not changing state, please check whether the connectors are properly seated on both sides of the sensor cable (extruder and Einsy side). In case of incorrect wiring, you will see the IR sensor state as “0” (even when you insert a filament string).



Pict. 38 - Properly connected and seated filament sensor

13.3.2.2 Incorrectly seated IR sensor

Filament sensor should be seated as depicted in the picture above. For detailed information, please see the assembly manual.

13.3.2.3 Dust on the sensor - how to clean

This is not a common cause, but as a last measure, try to unscrew the filament cover and filament sensor itself. Clean the sensor in marked area as depicted in the picture below - the easiest way is to use a can of compressed air.



Pict. 39 - IR filament sensor

Before you mount the sensor back, connect the sensor cable (note the correct orientation) and turn on the printer. Open the **LCD menu - Support - Sensor info** and try to insert an allen key or a strand of black filament into the sensor (green arrow in picture 39). If the IR value has changed from 0 to 1, the filament sensor is working properly, which means you have probably a mechanical problem with the extruder (overtightened FS-lever, blocked steel ball, wrong magnet orientation). Please refer to [the assembly manual](#) and make sure that extruder is assembled properly.

13.3.2.4 IR sensor is defective

If you have tried all mentioned solutions without success, there is a possibility that the IR sensor is defective. In this case, please contact our support.

13.4 Clogged / jammed extruder

Material clogged in the extruder can cause problems with the printing or with the loading of a new filament.

- Heat the nozzle, remove the filament from the extruder, and cut the rod about 10 cm above the damaged part.

- The next step is to clean the extruder. There is a service hole on the right side of the extruder where you can access the hobbed pulley (pict. 41).
- Clean the hobbed pulley, then heat the nozzle before reloading the filament.
- If a problem persists, you will have to clean the nozzle.



Pict. 40 - Cleaning the extruder - you can see the hobbed pulley through the service hole

13.5 Nozzle cleaning



Do not touch the nozzle during these procedures as it is preheated and you may burn yourself!



To make cleaning easier, move the extruder head up. On the **LCD menu - Settings - Move axis - Move Z axis**. As you will be operating with the hotend.

Use a wire brush to clean the nozzle from the outside. Heat the nozzle before you do so.

Filament is pouring out a little

If the filament doesn't go through the extruder smoothly and only a small volume is coming out, first check if the extruder fan is working properly and that the temperature is set correctly (**PLA 210 °C; ABS 255 °C, HIPS 220 °C, PET 240 °C**). Also check that the filament was correctly loaded into the extruder.

If that is not the case. Follow the instructions below:

1. Heat the nozzle according to the filament you want to print from. Load the filament and push a **bundled acupuncture needle** (0.3-0.35 mm) into the nozzle from below - between 1 and 2 cm deep. Then remove it.

2. Choose **Load filament** option from the LCD menu and check if filament is extruded properly.
3. Push the **acupuncture needle** into the nozzle again and remove it. Repeat these steps a few times more. When the filament is extruded properly, the nozzle is clear.

None of the filament is going through the nozzle

If none of the filament is going through, then most likely, your hotend got clogged. In order to fully clear it, please follow these instructions:

1. Heat up the nozzle to 250 °C for PLA or 270°C for ABS jams.
2. Wait 3-5 minutes and then go to **LCD Menu - Load filament**. If you cleared the clog and the filament went through, simply lower the temperature to normal and re-do load filament again.
3. If the filament loads successfully, you can resume printing.



If the filament can be loaded and unloaded without any problem, yet it still causes trouble during the print, clean the inside of your hotend using the **Cold pull technique**. Follow the guide at help.prusa3d.com.

13.6 Replacing / changing the nozzle



If you are replacing the **Olsson Ruby nozzle**, please visit this website for instructions, otherwise you might damage it!

<http://support.3dverkstan.se/article/66-the-olsson-ruby-instructions-for-use> .



CAUTION: Heated parts can cause severe burns! Be extra careful around the hotend thermistor leads. You can break them off easily

- 1) Gain better access to the nozzle by moving the extruder axis as high as possible: Go to **LCD Menu - Settings - Move Axis - Move Z**. Alternatively you can just hold down the knob for a few seconds. Rotate the knob to set the height.

Preheat the nozzle to 285°C (LCD Menu - Settings - Temperature - Nozzle). **Heating the nozzle is essential for this process!** Unload any loaded filament.

(optional) Unscrew the two screws on the print fan and the single screw securing the fan shroud. Remove both parts to get better access to the nozzle.

- 2) Hold the heater block with a 17mm spanner or adjustable wrench.
- 3) Using the supplied pliers, or preferably a 7mm socket, unscrew the nozzle. Be careful, the nozzle is still hot!
- 4) Make sure that the set temperatures (285°C) didn't change. Carefully screw the new nozzle in and tighten it. **Don't forget to use a spanner to hold the heater block.** Screw back the print fan and the fan shroud, load filament and you are ready to print.



Be careful, the nozzle is hot during this whole process and can cause burns!
Be careful around the hotend thermistor leads, you can break them easily.
Be careful, you can bend the heatbreak easily.

It is a good practice to run [6.3.9 First layer calibration](#) after changing the nozzle!

When the nozzle is fully screwed into the heater block, there is still a small gap between them. That's **normal**, do not try to overtighten the nozzle to get rid of the gap.

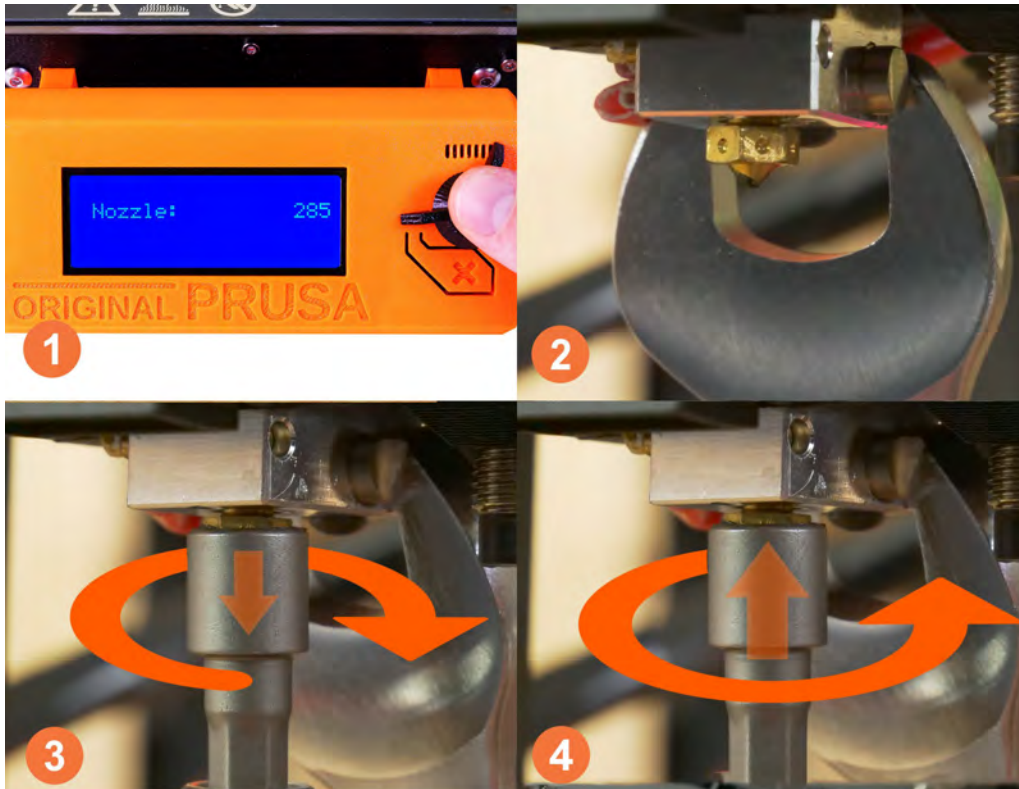

Pict. 41 - Nozzle change

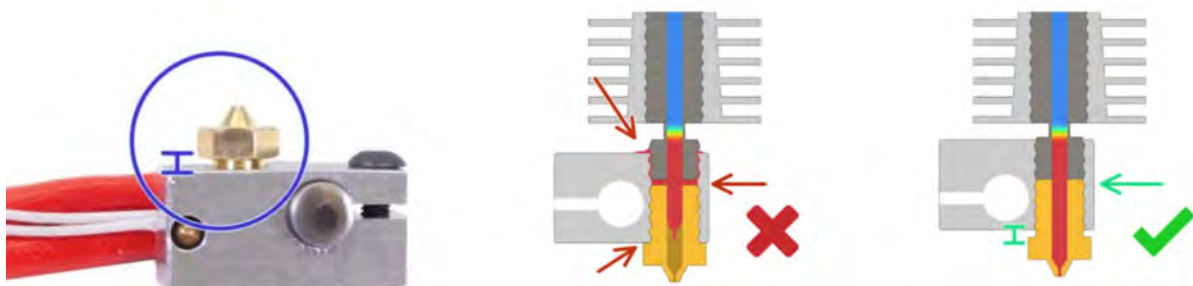

Pict. 42 - A gap between a fully screwed in nozzle and the heater block

13.7 Printing problems

13.7.1 Layers break and split when printing from ABS material

ABS material has a higher thermal expansion than other materials. We suggest other materials like PET, HIPS or PLA when you print larger models.

13.7.2 Models contain either too much or not enough of the filament

You can manage the filament flow during the print. Use the LCD-knob and choose **LCD Menu - Tune - Flow - xx%** where you can adjust the filament flow. Pronterface users can enter the value M221 Sxx into the command line.



When you change the filament flow, the next print will use the same settings unless you change it again in the menu, or reset the printer, or unplug it from the power source.

13.8 Problems with finished models

13.8.1 Model breaks and/or is easily damaged

This is a typical feature of larger models printed from ABS. If you have set the temperature properly, the printer is away from drafts and object design is right, the printed object should not break. The easiest way to avoid breaking, or overall model fragility, is to choose a different material. The strongest are PET, HIPS and PLA; while PLA has low heat resistance, PET is the firmest and has the lowest thermal expansion.



When parts break and there is no spare time to reprint the model you can use super glue or any other glue for plastics for temporary fix :).

13.9 Updating printer firmware

Flashing the printer's firmware brings various benefits. New firmware releases come with new features or bugfixes, so running the latest firmware is highly recommended. The flashing procedure is simple: it requires a USB 2.0 Type B cable, PrusaSlicer and the correct firmware file.

Windows users should download the latest Drivers & Apps package from <https://www.prusa3d.com/drivers/> and install them. Make sure that "Drivers" and "PrusaSlicer" are selected in the components list. MacOS and Linux users should download only PrusaSlicer. At the same web address, find the correct firmware file for your printer. Keep in mind that firmware files are different for each model.

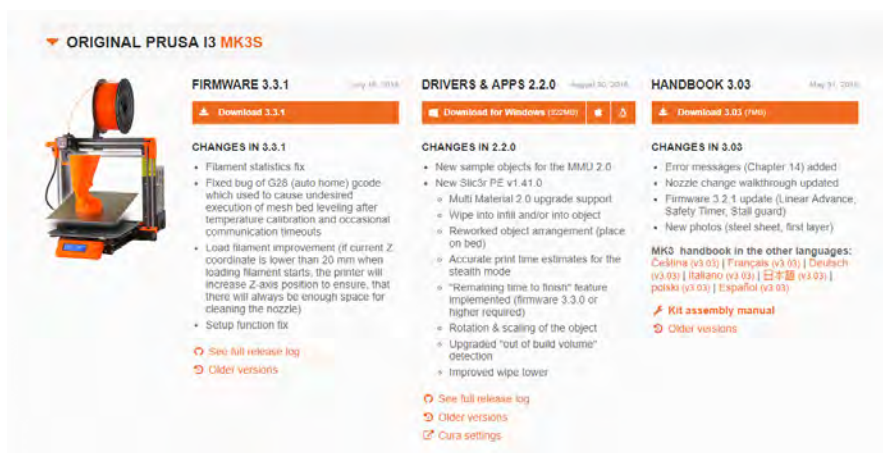

Pict. 43 - Firmware and Drivers & Apps packages at www.prusa3d.com/drivers

To flash the firmware, connect your 3D printer to your PC using a USB 2.0 Type B cable, and then start PrusaSlicer. Go to **Configuration - Flash printer firmware** and a new window will pop up. Check whether your printer has been correctly recognized, then click the Browse button and select the firmware file. Finally, select "**Flash!**" and wait for the process to finish. If everything went well, the printer will restart itself at the end of the flashing process. You can now disconnect the printer and check the firmware version in the printer's LCD menu.

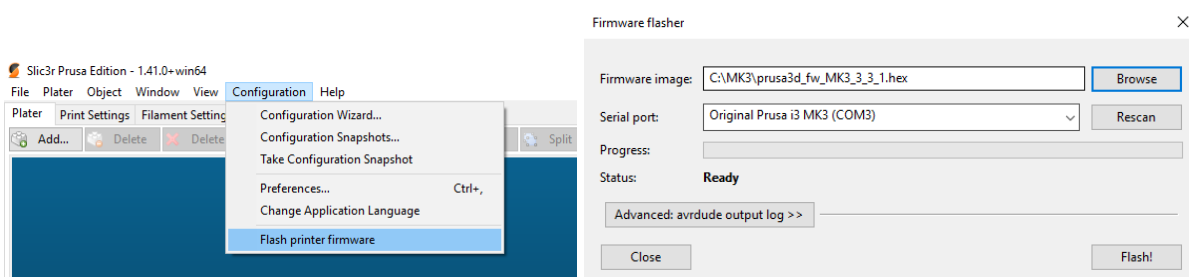

Pict. 44 - Upgrading firmware in PrusaSlicer

13.10 Linearity correction

Linearity correction is based on the Trinamic stepper driver feature that allows the definition of custom current-waveform. Go to **LCD Menu - Settings - Linearity correction** to adjust any of the three axes based on our tutorial article 'Extruder linearity correction calibration' at <https://help.prusa3d.com>



14 FAQ - common issues when assembling the printer kit

14.1 Printer is rocking - YZ frame - geometry check

If your printer is rocking on the table, please check Step 10 of Y-axis assembly - **YZ frame - geometry check**.

All the components are cut, or drilled, by a machine for the highest precision, but with uneven tightening, it is possible to warp the frame.

- Using your hand, try to wiggle with the frame sides and check whether some corners are lifting up or not.
- In case you find some imperfections, release the screws, press the extrusions against the FLAT SURFACE and tighten them again.



Pict. 45 - Proper way to tighten the frame, plates and aluminum extrusion together.

14.2 Printer stops printing soon after start

Extruder is likely to be overheated. Make sure the nozzle fan is working properly. If not, please inspect its connection according to the assembly manual.

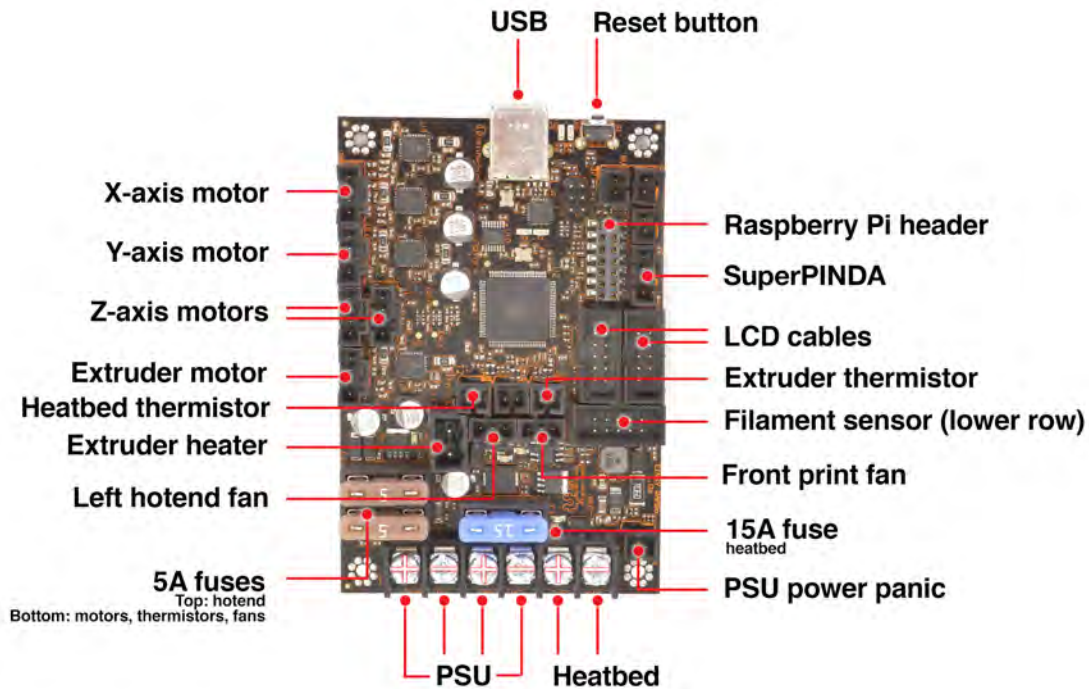

Pict. 46 - Proper wiring of the connectors

14.3 Printer can't read the SD card

First, make sure that the **file name** on the SD card **does not contain special characters** - otherwise the file could not be displayed on the LCD. Also, make sure that the SD card is formatted with the FAT32 standard. If everything is OK and the card is readable on the computer, check the EXT2 wiring (from electronics to the LCD). If the cable is connected properly, try to swap the cables.

14.4 Loose X- and/or Y-axis belts

Check if both belts are properly tightened, loose belts would cause a printer malfunction and prevent proper printing. The easiest way to check is printing a round object - if any of the belts are not tightened properly the result is an irregular shape instead of a perfect circle. Y-axis belt is located under the heatbed, X-axis belt moves the extruder. See the pictures with properly tightened belts.



You can check the belt status under **LCD Menu - Support - Belt status** after successfully running a selftest. You can also refresh the values by running an independent Belt test. The values **should not be under 240 and above 300**, but there is no single ideal value. The number does not represent any quantity.

The belt status is a unitless number measured as an average load on the stepper motor. Lower value corresponds to higher tension (higher motor load), a higher value means looser belt (less motor load).



Pict. 47 - A properly-tightened Y-axis belt under the heatbed

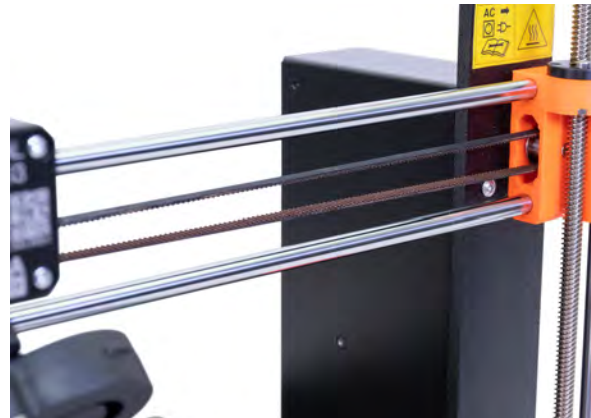

Pict. 48 - A properly-tightened X-axis belt

14.5 Cables detached from the heatbed

Do not forget to use a textile sleeve on heatbed cables and attach the cables properly so they won't restrict movement during printing.



Pict. 49 - Cables should be wrapped in a textile sleeve

15 FAQ - Error messages

You can find more info about error messages and their solutions at help.prusa3d.com.

15.1 Printer has not been calibrated yet

This error message appears after the assembly of your printer or after factory resetting all data. It will remain on the main LCD screen until you successfully calibrate the printer. In order to properly calibrate your printer, follow instructions in chapter [6.3.5 Calibrate XYZ \(kit only\)](#).

15.2 Distance between the tip of the nozzle and bed surface has not been set yet

This error message occurs after you successfully finish all of the calibration parts, except for the First layer calibration. Therefore, follow the instructions in chapter [6.3.9 First layer calibration \(kit only\)](#).

15.3 MINTEMP

The MINTEMP error occurs when at least one of the temperature readouts of the hotend or the heatbed drops below 10°C. It is a safety feature that prevents the printer from overheating in case of a faulty thermistor. You should avoid having the printer near an air-conditioning unit or in a garage, where the ambient temperature might be below 10°C.

Make sure to distinguish between the **MINTEMP** error and the **MINTEMP BED** error.

- MINTEMP - problem with the hotend temperature readout
- MINTEMP BED - problem with the heatbed temperature readout

15.4 MAXTEMP

The MAXTEMP error occurs when at least one of the temperature readouts of the hotend or the heatbed is higher than 310°C. It is a safety feature that prevents the printer from overheating uncontrollably. Check if the thermistor cable is not damaged and look for overtightened zip-ties around the cables leading to the electronics board.

15.5 Thermal runaway

The 'Thermal runaway error' occurs when the temperature readout of the hotend drops by 15°C for more than 45 seconds or heatbed for more than 4 minutes while printing. It is a safety feature which prevents the heater from reaching dangerously high temperatures if the thermistor becomes loose. It can also happen when you have the printer near an air-conditioning unit or an open window. We have described more troubleshooting options at help.prusa3d.com.

15.6 Preheat error

The Preheat error message occurs when there is a problem with the preheat process. This usually means that there is something preventing the printer from heating up in proper time. You should check whether your hotend or heatbed thermistors are properly seated. We have described more troubleshooting options at help.prusa3d.com.

15.7 File incomplete. Continue anyway?

This error message occurs when there is a problem with the generated G-code and it could potentially fail the whole print. **The most common cause is removing the SD card too early from your PC while the G-code was still exporting.** The printer automatically looks for the command M84 (disable motors) in the end section of a g-code file. If it's not detected, you will get a warning. You can still continue printing if you wish, but you should probably examine the file. Files generated by vast majority of slicers should be OK with this control, but you may experience problems with some less common software. We recommend using PrusaSlicer.

15.8 PRINT FAN ERROR

PRINT FAN ERROR error message occurs when the print fan does not receive any RPM (Revolutions per Minute) readings. In other words, there is something preventing it from spinning. Check the fan for any plastic debris and clean it if necessary. Also, make sure that the fan is properly plugged into the electronics and that the cable is undamaged.

15.9 EXTR. FAN ERROR

The EXTR. FAN ERROR message appears when the extruder fan does not receive any RPM (Revolutions per Minute) readings. In other words, there is something preventing it from spinning. Check the fan for any plastic debris and clean it if necessary. Also, make sure that the fan is properly plugged into the electronics board and that the cable is undamaged.

15.10 Blackout occurred. Recover print?

This error message' appears if the power goes off for a longer period of time during printing, and the hotend and heatbed already cooled down. The printer will wait for your input. Check if the object is still attached to the heatbed and then you can safely resume the print.

15.11 Please open the idler and remove the filament manually

This error message occurs when the automatic filament unloading process did not work properly and you need to remove the filament manually. Follow our guide at help.prusa3d.com to fix this issue.

15.12 Static memory has been overwritten

This error message should not appear on our official firmware releases as these have already gone through our testing. However, it can appear in self- or community-built firmware versions. The easiest solution is to flash in an official firmware [13.9 Updating printer firmware](#).

Print and share!

Do not forget to tag your prints with #prusai3MK3S+ while sharing so we can find, pin and showcase them with our

Pinterest

<http://www.prusa3d.com/original-prusa-i3-prints/>

Happy Printing :)