

# PORTABLE AUTOMATIC ICE MAKER

## User Manual

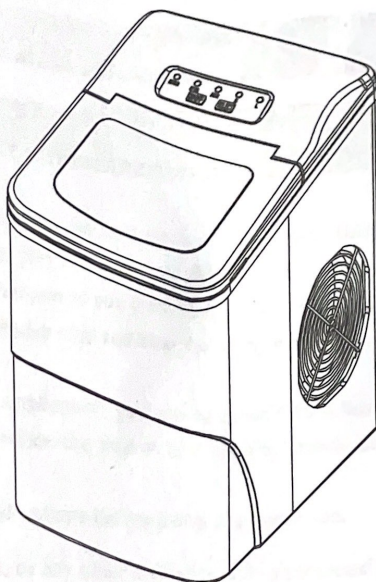

**HZB-12/B**

# **TABLE OF CONTENTS**

**PREPARING YOUR ICE MAKER FOR USE..... 2**  
    **IMPORTANT SAFETY TIPS..... 2**  
**GETTING TO KNOW YOUR UNIT..... 5**  
**OPERATING PROCEDURES & MAINTENANCE..... 6**  
    **POSITION OF CONTROL PANEL & FUNCTION..... 6**  
    **UNPACKING YOUR ICE MAKER..... 7**  
    **CONNECTING YOUR ICE MAKER..... 7**  
    **CLEANING AND MAINTAINING YOUR ICE MAKER..... 7**  
**USING YOUR ICE MAKER..... 8**  
**TROUBLESHOOTING..... 8**  
**TECHNICAL PARAMETERS & CIRCUIT DIAGRAM..... 9**  
**EXPLOSIVE DRAWINGS..... 10**

## PREPARING YOUR ICE MAKER FOR USE

Your health and safety are top concerns for us.

This is the safety alert symbol:



These words below mean:

Dire consequences may occur if you don't strictly follow the instructions.

 **DANGER**

 **WARNING**

All safety messages come with the alert symbol or the word "DANGER" , "WARNING". All safety messages will tell you what the potential hazard is, how to reduce the chance of injury, and what could happen to you if the instructions are not followed. For your safety, please always read and obey the safety messages.

When using electrical appliances, you are supposed to follow all these basic safety precautions below to reduce the risk of fire, electric shock, and injury to persons or property. Please read all these instructions before using any appliance.

- Do not operate this, or any other appliance with a damaged cord.
- If the supply cord is damaged, it must be replaced by the manufacturer or its service agent or a similarly qualified person in order to avoid hazards.
- This ice-maker must be positioned where the plug is accessible.
- Connect to the properly grounded outlets only.
- No other appliance should be plugged into the same outlet.
- Be sure that the plug is fully inserted into the socket.
- Do not run the power cord over carpeting or other heat insulators. Do not cover the cord. Keep the cord away from traffic areas, and do not submerge it in water.
- We do not recommend the use of an extension cord, as it may overheat and become a risk of fire. If you must use an extension cord, use No.14AWG minimum size and rated no less than 1875 watts.

- Unplug the ice maker before cleaning or making any repairs or servicing.
- Exercise caution and use reasonable supervision when the appliance is used near children.
- Do not use your ice-maker outdoors. Keep the ice-maker away from direct sunlight and make sure that there is at least 6 inches of space between the back of your unit and wall. Keep a minimum distance of 6 inches on each side of your unit free.
- Do not use any liquid to make the ice-cube other than water.
- Do not clean your ice maker with flammable fluids. The fumes can create a fire hazard or explosion.
- Do not tip over.
- If the ice maker is brought in from outside during wintertime, give it a few hours to warm up to room temperature before plugging it in.
- **WARNING** – This appliance must be earthed.
- **DANGER** – Risk Of Fire or Explosion. Flammable Refrigerant Used. Do Not Use Mechanical Devices To Defrost Ice Maker. Do Not Puncture Refrigerant Tubing.
-  **DANGER** – Risk Of Fire Or Explosion. Flammable Refrigerant Used. To Be Repaired Only By Trained Service Personnel. Do Not Puncture Refrigerant Tubing.
- **CAUTION** – Risk Of Fire Or Explosion. Flammable Refrigerant Used. Consult Repair Manual/Owner's Guide Before Attempting To Install or Service This Product. All Safety Precautions Must be Followed.
- **CAUTION** – Risk Of Fire Or Explosion. Dispose Of Property In Accordance With Federal Or Local Regulations. Flammable Refrigerant Used .
- **CAUTION** – Risk Of Fire Or Explosion Due To Puncture Of Refrigerant Tubing; Follow Handling Instructions Carefully. Flammable Refrigerant Used.
- The ice maker should be installed in accordance with the safety standard for Refrigeration Systems, ASHRAE15. The ice maker shall not be installed in corridors or hallways of public buildings.
- If the unit is with problem need to be maintained, that replacing with like components and that servicing shall be done by factory authorized service personnel, so as to minimize the risk of possible ignition due to incorrect parts or improper service.

**IMPORTANT:**

The wires in this mains lead are colored in accordance with the following code:

Green or Green with a strip yellow:

Grounding

White:

Neutral

ers or servicing.  
The appliance is used near

away from direct sunlight  
on the back of your unit  
of your unit free.

es can create a fire

it a few hours to

d. Do Not Use  
nt Tubing.

Used. To Be  
nt Tubing.  
sult Repair  
oduct. All

ce With

erant

for  
rs

To avoid a hazard due to instability of the appliance, it must be placed at an even or flat surface.

Black:

Live



# GETTING TO KNOW YOUR UNIT

## General instruction

1. Ice scoop.
2. Ice full sensor
3. Ice basket
4. Top cover with transparent window
5. Air exhausting
6. Water drain cap: at front btm side of the unit.
7. MAXIMUM WATER LEVEL: 

*Remove the ice basket, you can see the water level mark.*

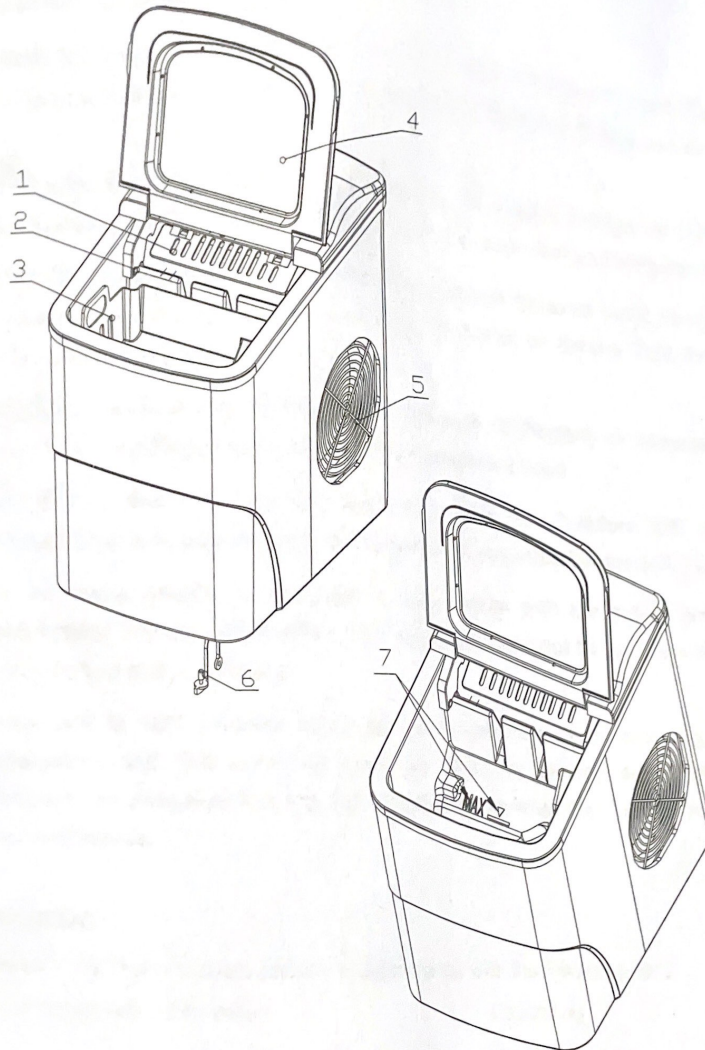

## OPERATING PROCEDURES & MAINTENANCE

### Position of control panel & function

Control Panel: Easy to use, visible functions touch display setting.

- A. Selected ice size displaying: Small and Large.
- B. Power indicator
- C. Ice-Full indicator
- D. Water shortage indicator
- E. On/Off Button
- F. Button to select ice cube size.

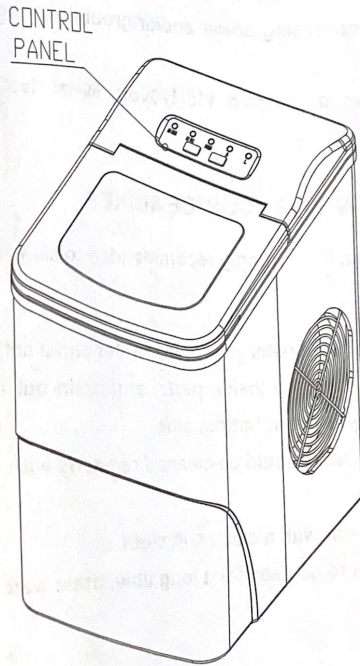
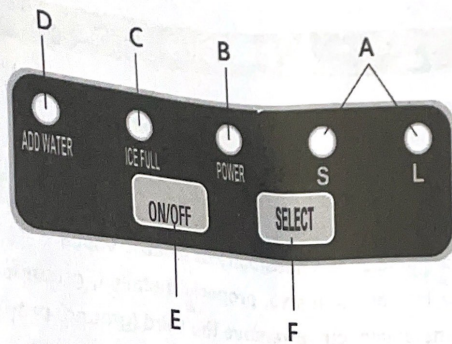

### UNPACKING YOUR ICE MAKER

1. Remove the exterior and interior packaging. Check if the ice basket and ice scoop are inside. If any parts are missing, please contact our customer service.
2. Remove the tapes for fixing the ice shovel, ice basket & ice scoop. Clean the tank & ice basket.
3. Put the ice maker on a level & flat countertop without direct sunlight and other sources of heat (i.e.: stove, furnace, radiator). Make sure that there is at least 4 inches gap between the back & LH/RH sides with the wall.
4. Allow one hour for the refrigerant fluid to settle before plugging the ice maker in.
5. The appliance must be positioned so that the plug is accessible.

**WARNING: fill with potable water only. Only use drinking water.**

### CONNECTING YOUR ICE MAKER

#### DANGER

\* Improper use of the grounded plug can result in the risk of electrical shock. If the power cord is damaged please call our customer service.

1. This unit should be properly grounded for your safety. The power cord of this appliance is equipped with a three-prong plug which mates with standard three prong wall outlets to minimize the possibility of electric shock.
2. Plug your appliance into an exclusive, properly installed, grounded wall outlet. Do not, under any circumstances, cut or remove the third (ground) prong from the power cord. Any questions concerning power and/or grounding should be directed toward a certified electrician.
3. This appliance requires a standard 110-120volt, 60Hz electrical outlet with three-prong ground.

### CLEANING AND MAINTAINING YOUR ICE MAKER

Before using your ice maker, it is strongly recommended to clean it thoroughly.

1. Take out the ice basket.
2. Clean the interior with diluted detergent, warm water and a soft cloth.
3. Then use the water to rinse the inside parts, and drain out the water by unplugging the drain cap on front bottom side.
4. The outside of the ice maker should be cleaned regularly with a mild detergent solution and warm water.
5. Dry the interior and exterior with a clean soft cloth.
6. When the machine is not to be used for a long time, drain water completely & dry the interior.



## USING YOUR ICE MAKER

1. Open the cover, remove the ice basket and pour water into tank.  
Keep water level below the water level mark.
2. Press "ON/OFF" button on the control panel to begin the ice making cycle.
3. Select the ice cube size by pressing the "Select" button. If the room temperature is lower than 60°F, it is recommended to select small ice cube in order to avoid ice sticking together.
4. The ice making cycle lasts approx. 6 to 13 minutes, depending on selection of ice cube size and the room temperature. The recommended room temperature is 50°F to 105°F. If water pump can't inject water, the ice maker will stop automatically, and the "Add Water" indicator will be on. Press "ON/OFF" button, fill water up to the max. water level mark and press "ON/OFF" button again to turn on the unit again. Allow the refrigerant liquid inside the compressor at least 3 minutes to settle before restarting.
6. The ice maker stops when the ice basket is full and the "Ice FULL" indicator will be on. **Warning: Direct sunlight or sunlight reflection may cause infrared sensor malfunction. If the unit doesn't stop even ice cubes obstruct sensor, move the unit where no sunlight.**
7. Change water in the water reservoir every 24 hours to ensure a reasonable hygiene level. If unit isn't to be used, drain all the water and dry the tank.

## TROUBLESHOOTING

Problem	Possible Cause	Solution
"Add Water" indicator is on.	Lack of Water.	Stop the ice maker, fill water, and press "ON/OFF" button again to restart the unit.
"Ice" indicator is on.	Ice is full in basket.	Remove ice from ice basket. Continuous press "Select" button <b>5 seconds</b> , the unit could make ice 10 cycles even "Ice" indicator is on.
Ice cubes stick together.	The ice making cycle is too long.	Stop the ice maker, and restart it when the ice blocks melt. Select the small size ice cube selection.
	Water temperature in the inner tank is too low.	Replace the water. Temperature of water recommended at 40°F -90°F
Ice making cycle is normal but no ice formed.	Room temperature or water temperature in the inner tank is too high.	The room temperature should be 50°F - 105°F, water temperature should be 40°F -90°F
	Refrigerant in cooling system leaks.	Verified by a qualified technician.
	Pipe in the cooling system is blocked.	Verified by a qualified technician.

# TECHNICAL PARAMETERS & CIRCUIT DIAGRAM

<b>Model</b>	HZB-12/B	
<b>Protection Type</b>	I	
<b>Power</b>	115V/60Hz	
<b>Ice Making Current</b>	1.7A	
<b>Ice Harvest Current</b>	2.0A	
<b>Refrigerant</b>	R600a 0.74Oz/21g	
<b>Design Pressure</b>	High Side	290Psig
	Low Side	88Psig
<b>Vesicant</b>	C <sub>5</sub> H <sub>10</sub>	
<b>Net Weight</b>	6.7Kg	
<b>Dimension (W * D * H)</b>	222x313x320mm	
<b>Enclosure</b>	Plastic	

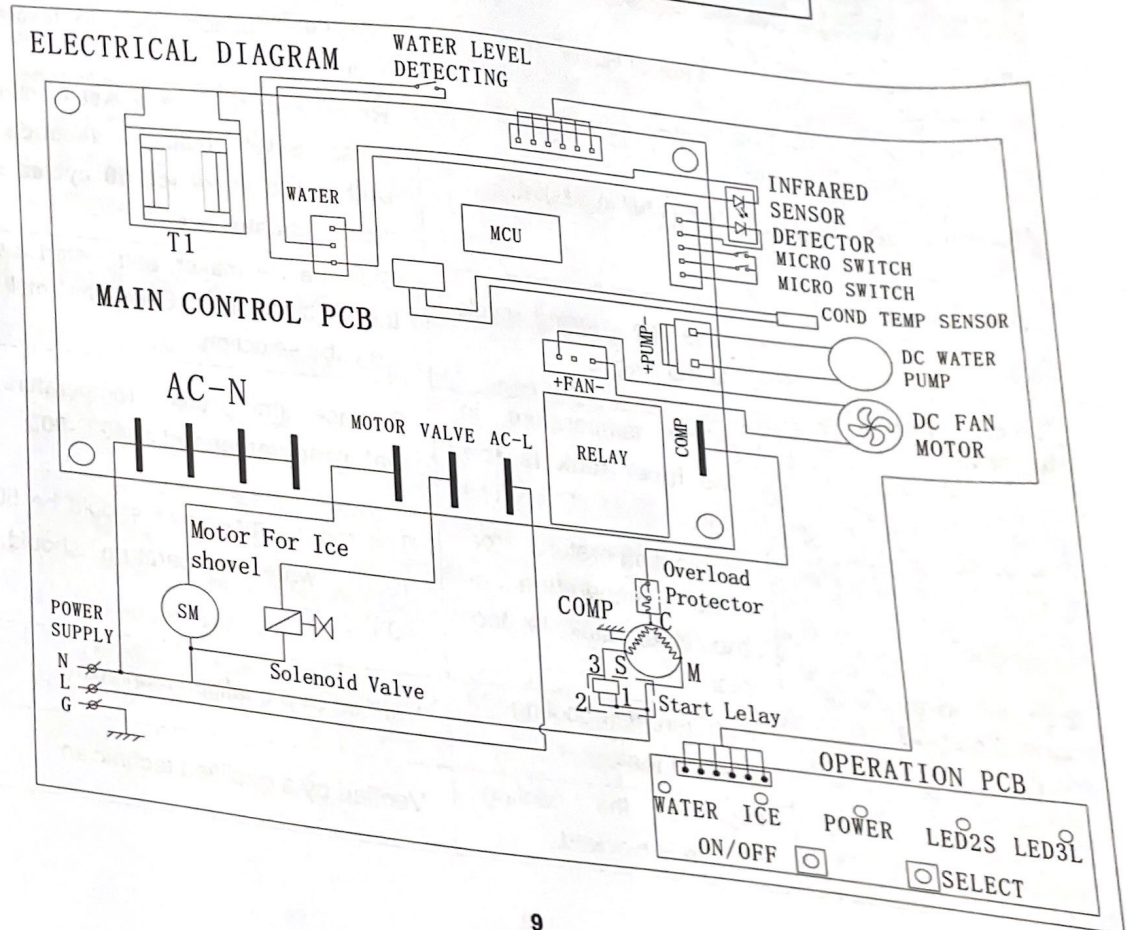

# EXPLOSIVE DRAWINGS

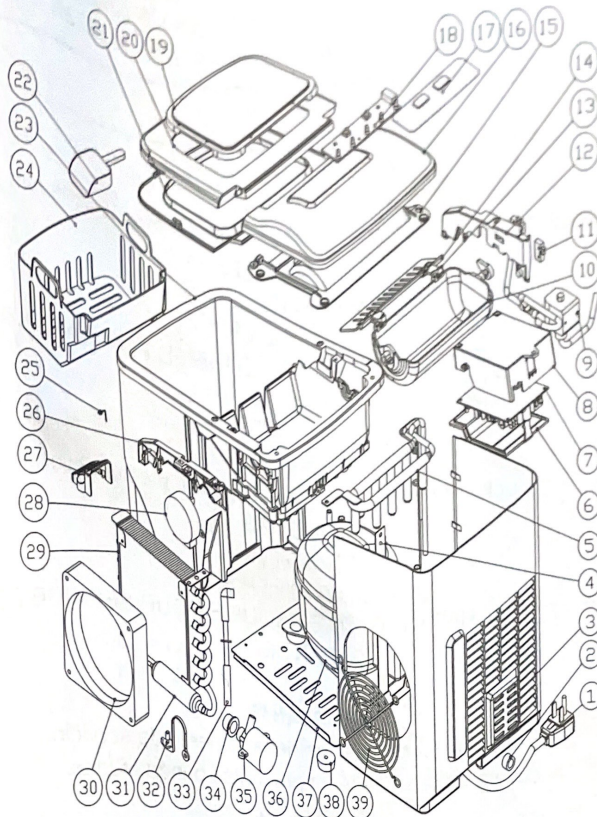

S/N	Part description	Qty/ Per	S/N	Part description	Qty /Per	S/N	Part description	Qty/ Per
1	Power cord	1	15	Back btm panel	1	29	Condenser	1
2	plastic clip	1	16	Back top panel	1	30	DC Fan motor	1
3	Back panel	1	17	Touch pad	1	31	Copper tube filter	1
4	Plate back support	1	18	Displaying PCB	1	32	Nylon plug drain	1
5	Evaporator	1	19	Clear window	1	33	Water Supply pipe	1
6	Control box cover	1	20	Front top panel	1	34	Silicon pump sealing	1
7	Main PCB	1	21	Front btm panel	1	35	DC water pump	1
8	Control box	1	22	Ice shovel	1	36	Compressor	1
9	Magnetism valve	1	23	Foaming asm	1	37	Plate bottom	1
10	Ice making box	1	24	Ice basket	1	38	Rubber foot	2
11	Micro switch	2	25	Stainless wire	1	39	Air grille	1
12	Inner tank bracket, LH	1	26	Inner tank brackct, RH	1			
13	Ice scoop link	2	27	Water filter	1			
14	Ice scoop	1	28	Synchronous motor	1			